

Register your product and get support at  
[www.philips.com/welcome](http://www.philips.com/welcome)



32PFL9603  
32PFL9613  
37PFL9603  
42PFL9603  
42PFL9703  
42PFL9803  
47PFL9603  
47PFL9703  
52PFL9703

EN LCD television

IT Televisore LCD

DE LCD-Fernsehgerät

ES Televisor LCD

FR Téléviseur LCD

PT Televisor LCD

NL LCD televisie

EL Τηλεόρασης LCD

310431527053



**PHILIPS**



---

# Table of contents

---

## 1 Important 3

- 1.1 Safety 3
  - 1.2 Care of the screen 3
  - 1.3 Recycling 3
- 

## 2 Your TV 4

- 2.1 Television overview 4
  - 2.2 Product highlights 5
- 

## 3 Getting started 5

- 3.1 Position the TV 5
  - 3.2 Wall mounting - VESA 6
  - 3.3 Remote control batteries 7
  - 3.4 Antenna cable 7
  - 3.5 Power cable 7
  - 3.6 First time installation 7
- 

## 4 Use your TV 8

- 4.1 Switch on or off - Standby 8
  - 4.2 Watch TV 9
  - 4.3 Watch channels from a digital receiver 9
  - 4.4 Watch connected devices 9
  - 4.5 Watch a DVD 10
  - 4.6 Select a Teletext page 10
  - 4.7 Change Ambilight mode 11
- 

## 5 Use more of your TV 12

- 5.1 Remote Control 12
  - 5.2 LightGuide brightness 15
  - 5.3 TV menus 15
  - 5.4 Picture and sound settings 16
  - 5.5 Ambilight 19
  - 5.6 Teletext 20
  - 5.7 Create favourite channel lists 21
  - 5.8 Electronic Programme Guide 22
  - 5.9 Timers and locks 24
  - 5.10 Subtitles 25
  - 5.11 Watch and play photos, MP3... 25
  - 5.12 Listen to digital radio channels 27
  - 5.13 Software update 28
- 

## 6 Channel installation 30

- 6.1 Automatic channel installation 30
  - 6.2 Manual channel installation 31
  - 6.3 Rearrange stored channels 32
  - 6.4 Channel management 32
  - 6.5 Digital reception test 33
  - 6.6 Factory settings 33
- 

## 7 Connections (DVD, receiver, ...) 34

- 7.1 Connections overview 34
  - 7.2 About connections 35
  - 7.3 Connect your devices with the Connection assistant 36
  - 7.4 Connect your devices without the Connection assistant 36
  - 7.5 Connection setup 42
  - 7.6 Preparing for digital services 43
  - 7.7 PC network 44
- 

## 8 Technical data 50

---

## 9 Troubleshooting 52

---

## 10 Index 54

---

### UK Digital TV switchover info 56

Remote control setup codes at the end of this book.

Register your product and get support at [www.philips.com/welcome](http://www.philips.com/welcome).

2008 © Koninklijke Philips Electronics N.V. All rights reserved. Specifications are subject to change without notice. Trademarks are the property of Koninklijke Philips Electronics N.V. or their respective owners.

Philips reserves the right to change products at any time without being obliged to adjust earlier supplies accordingly.

The material in this manual is believed adequate for the intended use of the system. If the product, or its individual modules or procedures, are used for purposes other than those specified herein, confirmation of their validity and suitability must be obtained. Philips warrants that the material itself does not infringe any United States patents. No further warranty is expressed or implied.

#### Warranty

No components are user-serviceable. Do not open or remove covers and do not insert objects in the ventilation slots or insert objects not suitable for the specific connectors. Repairs may only be done by Philips Service Centres and official repairshops. Failure to do so shall void any warranty, stated or implied.

Any operation expressly prohibited in this manual, any adjustments, or assembly procedures not recommended or authorised in this manual shall void the warranty.

#### Pixel characteristics

This LCD product has a high number of colour pixels. Although it has effective pixels of 99,999% or more, black dots or bright points of light (red, green or blue) may appear constantly on the screen. This is a structural property of the display (within common industry standards) and is not a malfunction.

#### Open source software

This television contains open source software. Philips hereby offers to deliver or make available, upon request, for a charge no more than the cost of physically performing source distribution, a complete machine-readable copy of the corresponding source code on a medium customarily used for software interchange. This offer is valid for a period of 3

years after the date of purchase of this product.

To obtain the source code, write to Philips Innovative Applications N.V. Ass. to the Development Manager Pathoekeweg 11 B-8000 Brugge Belgium

#### Compliance with EMF

Koninklijke Philips Electronics N.V. manufactures and sells many products targeted at consumers, which, like any electronic apparatus, in general have the ability to emit and receive electromagnetic signals.

One of Philips' leading Business Principles is to take all necessary health and safety measures for our products, to comply with all applicable legal requirements and to stay well within the EMF standards applicable at the time of producing the products. Philips is committed to develop, produce and market products that cause no adverse health effects. Philips confirms that if its products are handled properly for their intended use, they are safe to use according to scientific evidence available today. Philips plays an active role in the development of international EMF and safety standards, enabling Philips to anticipate further developments in standardisation for early integration in its products.

#### Mains fuse (UK only)

This TV is fitted with an approved moulded plug. Should it become necessary to replace the mains fuse, this must be replaced with a fuse of the **same value as indicated** on the plug (example **10A**).

1. Remove fuse cover and fuse.
2. The replacement fuse must comply with BS 1362 and have the ASTA approval mark. If the fuse is lost, contact your dealer in order to verify the correct type.
3. Refit the fuse cover.

In order to maintain conformity to the EMC directive, the mains plug on this product must not be detached from the mains cord.

#### Copyrights



VESA, FDMI and the VESA Mounting Compliant logo are trademarks of the Video Electronics Standards Association.



Manufactured under license from Dolby Laboratories. 'Dolby', 'Pro Logic' and the double D symbol **DD**, are trademarks of Dolby Laboratories.



Manufactured under license from BBE Sound, Inc. Licensed by BBE, Inc under one or more of the following US patents: 5510752, 5736897. BBE and BBE symbol are registered trademarks of BBE Sound Inc.

Windows Media is either a registered trademark or trademark of Microsoft Corporation in the United States and/or other countries

® Kensington and MicroSaver are registered US trademarks of ACCO World Corporation with issued registrations and pending applications in other countries throughout the world.



DLNA®, the DLNA logo and DNLA Certified™ are trademarks, service marks, or certification marks of the Digital Living Network Alliance.

All other registered and unregistered trademarks are the property of their respective owners.

# 1 Important

Read this user manual before you start to use this product.

Pay attention to this section and closely follow the instructions. The warranty does not apply to damage caused by not taking into account the instructions.

## 1.1 Safety

- To avoid short circuit, do not expose the product to rain or water.
- To avoid a risk of fire or electric shock do not place naked flame sources (e.g. lighted candles) close to the TV.
- Leave a space of at least 10cm (4 inches) all around the TV for ventilation.
- Keep away from radiators or other heat sources.
- Do not install the TV in a confined space such as a book case. Make sure that curtains, cupboards and so on cannot obstruct the air flow through the ventilation slots.
- To prevent damage, do not insert any object into the ventilation slots.
- Make sure the TV cannot fall down. Place the TV on a solid and flat surface and only use the stand provided with the TV.
- To prevent damaging the mains cord, do not place the TV, or anything else, on the cord. Damage to the cord may cause a fire or electric shock.
- When mounted on a swivel stand or VESA wall bracket avoid force coming on the mains plugs. Mains plugs that are partly loosened can cause arcing or fire.

## 1.2 Care of the screen

- Unplug the TV before cleaning.
- Clean the surface with a soft damp cloth. Do not apply any other substance (chemical or household cleaning agent). This may damage the screen.
- Do not touch, push or rub or strike the screen with anything hard as this may scratch, mar or damage the screen permanently.
- To avoid deformations and colour fading, wipe off water drops as soon as possible.

- Stationary images  
Avoid stationary images as much as possible. If you cannot, reduce screen contrast and brightness to prevent damage to the screen. Stationary images are images that remain on the screen for a long time. Examples of stationary images are: on screen menus, teletext pages, black bars, stock market information, TV channel logos, time displays, and so on.

## 1.3 Recycling

- Take the packaging to your local recycling centre.
- Dispose old batteries safely according local regulations.
- This product is designed and manufactured for material recycling and re-use.
- Do not dispose this product with other household waste. Inform yourself or ask your dealer about local environmentally safe recycling and local regulations. Uncontrolled waste disposal harms the environment and human health. (EEC 2002/96/EC)



## 2 Your TV

This section gives you an overview of the controls and functions of this TV.

### 2.1 Television overview

#### Controls

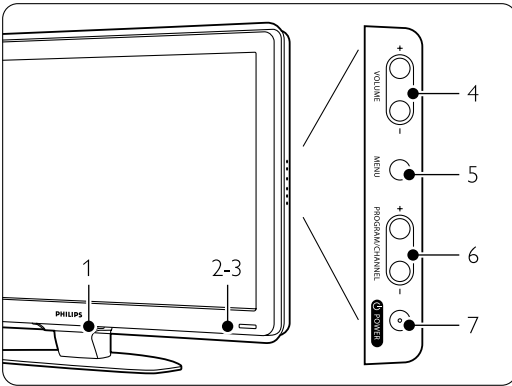

- 1 LightGuide
- 2 Indicator light
- 3 Remote control sensor
- 4 Volume up and down
- 5 Menu
- 6 Program/Channel up and down
- 7 Power switch

#### Connectors

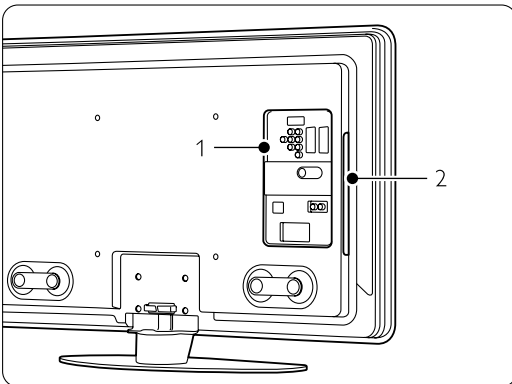

- 1 Back connectors
  - 2 Side connectors
- For more info see section 7 Connections.

#### Remote control

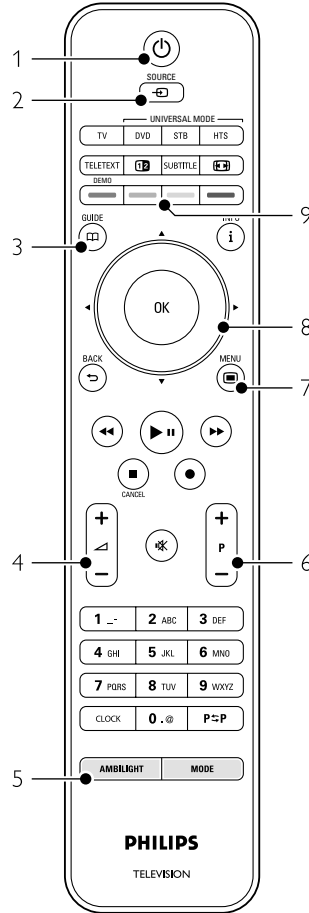

- 1 Switch On or switch to Standby
- 2 Watch a connected device - DVD,VCR ...
- 3 Programme guide
- 4 Volume up + or down -
- 5 Ambilight On or Off
- 6 Program/Channel up + and down -
- 7 Menu On or Off
- 8 Navigation and Rotary key
- 9 Colour keys

For more info see section 5.1 Remote control overview.

## 2.2 Product highlights

Your new TV is equipped with some of the most modern audio or video innovations. Your TV offers the following advantages ...

### Full High Definition LCD display

A full HD resolution of 1920x1080p, the highest resolution of HD sources. It offers a brilliant flicker-free progressive scan picture with optimum brightness and superb colours.

### Ambilight

For a more relaxed viewing experience and improved perceived picture quality.

### Perfect Pixel HD

Offers perfect picture quality from any source.

### 100Hz Clear LCD (if present)

100Hz Clear LCD gives a superior motion sharpness, better black level, high contrast with a flicker-free, quiet image and a larger viewing angle.

### DVB-T and DVB-C integrated tuner

Next to normal analogue TV broadcast your TV receives digital terrestrial and in certain countries also digital cable TV and radio broadcasts.

### Electronic Programme Guide - EPG

The EPG shows the scheduled digital TV programmes on screen. The guide can remind you when programmes start, switch the TV on, etc.

### HDMI connectors

HDMI connectors for highest quality high definition connectivity.

### USB connection / PC network connection

Multimedia connection for instantly view or play your photos or music.

### Universal remote control

Your TV remote control is a universal remote control that can operate other devices such as DVD players and recorders, digital receivers (STB) or Home Theatre Systems (HTS) of Philips and many other brands.

### MPEG4 broadcast (if available)

A higher quality videostandard offered by HD transmitted broadcasts.

## 3 Get started

This section helps you with the positioning and the first time installation of the TV.

### 3.1 Position the TV

Carefully read the safety precautions in section 1.1 Safety before you position the TV.

- Large screen TVs are heavy. Carry and handle the TV with at least two persons.
- The ideal distance from which to watch TV is three times its diagonal screen size.
- Position the TV where light does not fall directly on the screen.
- Dim lighting conditions in the room for best Ambilight effect.
- Position the TV 10 to 20cm away from the wall for the best Ambilight effect.
- Your TV is equipped with a Kensington Security Slot at the back of the TV for an anti-theft lock (not supplied).

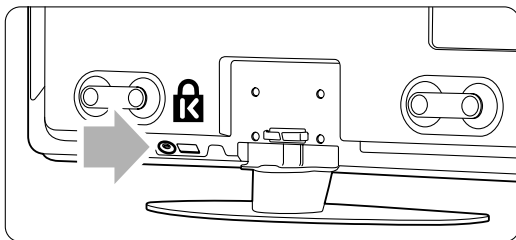

On 32" and 37" TV models.

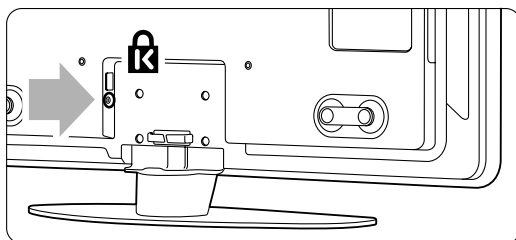

On 42", 47" and 52" TV models.

## 3.2 Wall mounting - VESA

### ⚠ Caution

Consider the TV's weight when you wall mount it. Improper mounting can result in severe injury or damage. Koninklijke Philips Electronics N.V. bears no responsibility for improper mounting or mounting that results in accident or injury.

Your TV is prepared for VESA compliant wall mounting. This bracket is not included. You need one of the VESA codes hereunder to purchase the bracket that fits your TV.

32" / 81cm	VESA MIS-F 200, 200, 8
37" / 94cm	VESA MIS-F 200, 200, 8
42" / 107cm	VESA MIS-F 300, 300, 8
47" / 119cm	VESA MIS-F 400, 400, 8
52" / 132cm	VESA MIS-F 400, 400, 8

Ask your dealer for more info on stands and wallmount brackets.

### The VESA fixation points

Locate the four fixation points at the back of the TV.

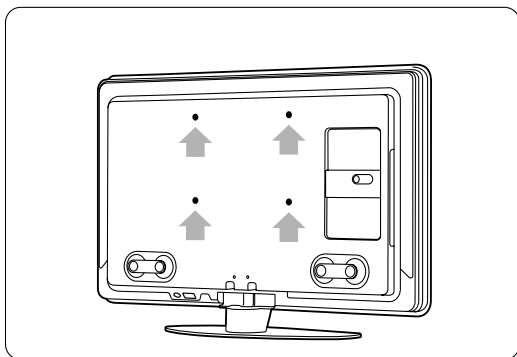

On a 32" / 81cm TV model.

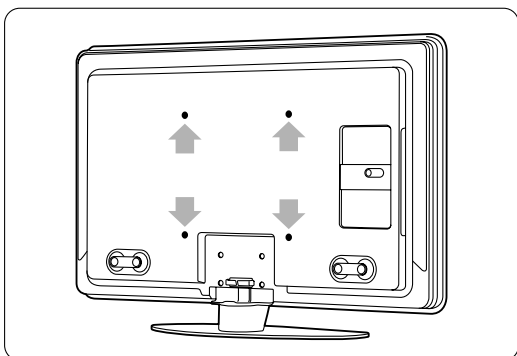

On other TV screensizes.

### Unmount the TV stand

- 1 Locate the four screws of the TV stand.  
The 32" / 81cm TV model has two screws.

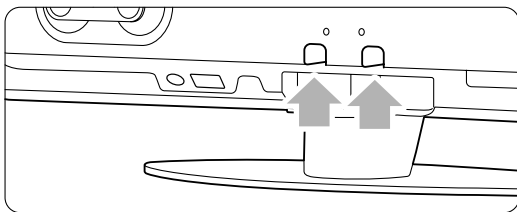

On a 32" / 81cm TV model.

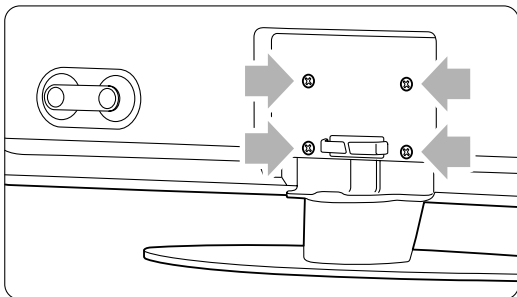

On other screensizes.

- 2 Unscrew the screws.

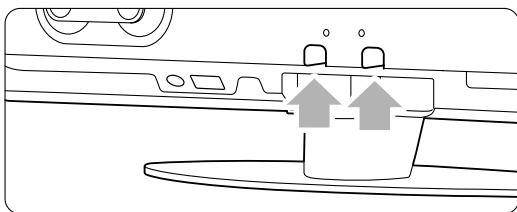

Two screws on the 32" / 81cm TV model.

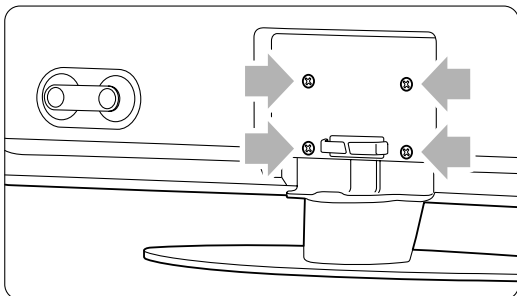

Four screws for other TV screensizes.

- 3 Lift the TV off the stand.



### 3.3 Remote control batteries

- 1 Open the battery cover on the back of the remote control.
- 2 Insert the 3 batteries supplied (Type AAA-LR03-1,5V). Make sure the + and - ends of the batteries line up correctly (inside of case is marked.)
- 3 Close the cover.

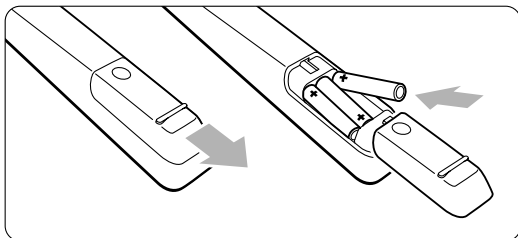

#### Note

Remove the batteries if not using the remote control for an extended period of time.

### 3.4 Antenna cable

- 1 Locate the antenna connection at the back of the TV.
- 2 Insert the antenna cable tightly into the Antenna socket.

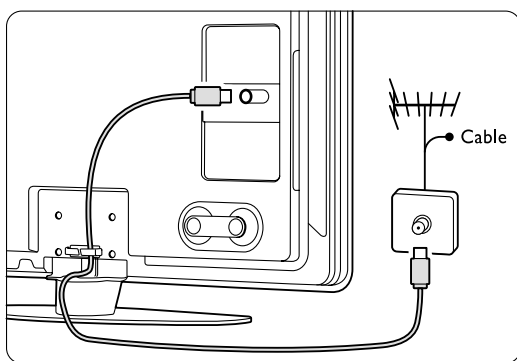

### 3.5 Power cable

Keep the mains plug at the wall socket accessible at all time.

The TV is never powered off completely and consumes energy unless the mains cord is physically unplugged.

Although this TV has a very low standby power consumption, unplug the mains cord if you do not use the TV for a long time to save energy.

- 1 Verify that your mains voltage corresponds with the voltage printed on the sticker at the back of the TV. Do not insert the mains cord if the voltage is different.
- 2 Insert the mains cord tightly.

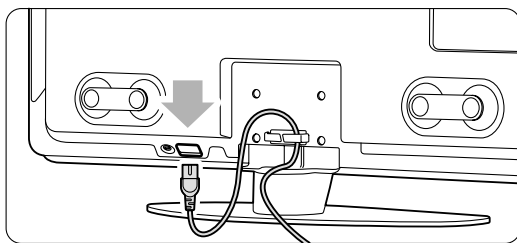

On 32" and 37" TV models.

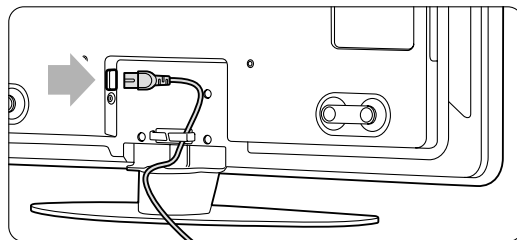

On 42", 47" and 52" TV models.

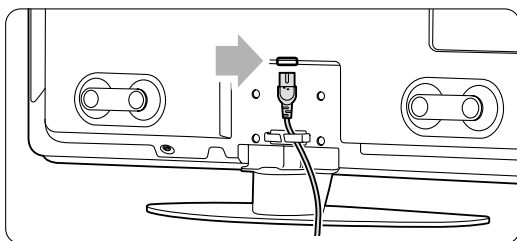

On 42PFL9803,

## 4 Use your TV



Learn how to operate your TV for daily use.

### 4.1 Turn on or off - Standby

#### Note

The TV may take up to 15 seconds to turn on.

To turn on the TV:

- Press  **Power** at the right of the TV if the standby indicator is off.
- Press  on the remote control if the standby indicator is on.

The LightGuide flashes during start up and turns on completely when the TV is ready for use.

To switch to standby:

- Press  on the remote control.

The LightGuide turns off and the standby indicator is on.

To turn off:

- Press  **Power** at the side of the TV.

Both the LightGuide and the standby indicator turn off.

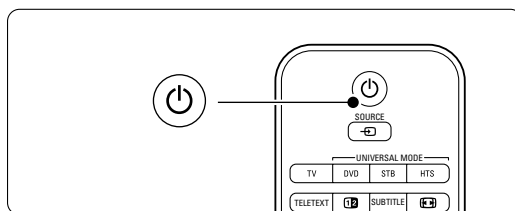
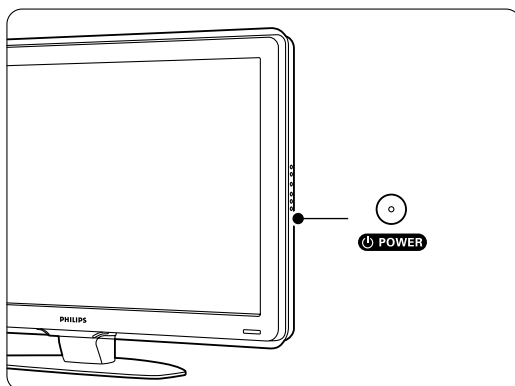

## 4.2 Watch TV

### 4.2.1 Switch channels

- To switch TV channels:
  - Press a number (1 to 999) or press **P+** or **P-** on your remote control.
  - Press **Program/Channel -** or **+** on the side controls of the TV.
- Press **P=P** to return to the previously viewed TV channel or connected device.

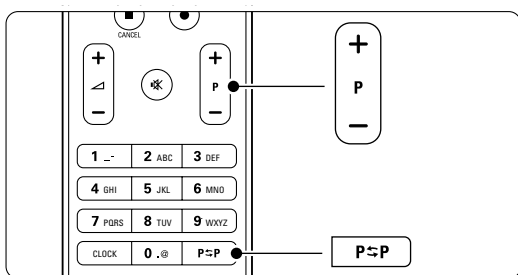

### 4.2.2 Adjust volume

- To adjust the volume:
  - Press **▲** or **-** on the remote control
  - Press **Volume +** or **-** on the side controls of your TV.
- To mute the sound:
  - Press **🔇**.
  - Press **🔇** again to restore the sound.

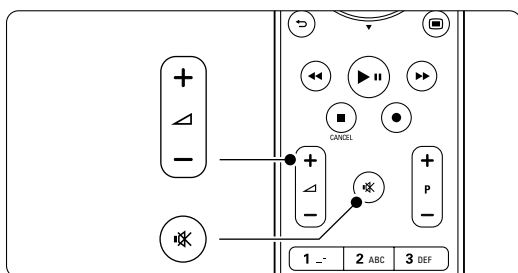

## 4.3 Watch channels from a digital receiver

- Switch on the digital receiver.  
The picture from your receiver automatically appears on the screen.
- Use the remote control of your digital receiver to select TV channels.

If the picture does not appear:

- Press the **Source** key.
- Press **▲** or **▼** to select where you connected your digital receiver.
- Press **OK**.

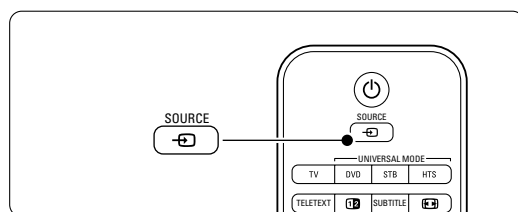

### Note

When you did not connect your devices yet, go to section **7 Connections**.

## 4.4 Watch connected devices

- Switch on the device.  
The picture from your device automatically appears on the screen.

If the picture does not appear:

- Press the **Source** key.
- Press **▲** or **▼** to select where you connected your device.
- Press **OK**.

### Note

When you did not connect your devices yet, go to section **7 Connections**.

## 4.5 Watch a DVD

- 1 Switch on your DVD player.
- 2 Insert a DVD disc in your player.  
The DVD picture automatically appears on the screen.
- 3 Press **Play** ► on the DVD player.

If the picture does not appear:

- 1 Press the **Source**  key.
- 2 Press ▲ or ▼ to select where you connected your DVD player.
- 3 Press **OK**.  
Wait a few seconds until the picture appears.
- 4 Press **Play** ►.

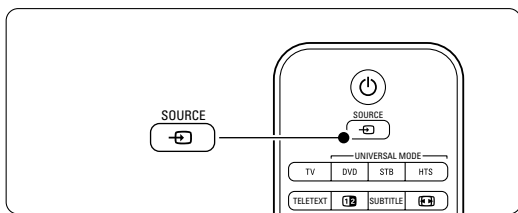

## 4.6 Select a Teletext page

Most TV channels broadcast information through Teletext.

To watch Teletext:

- 1 Press **Teletext**.  
The main index page appears.
- 2 To select a page of your choice:
  - Enter the page number with the number keys.
  - Press **P-** or **P+** or ▲ or ▼ or the  key to view the next or the previous page.
  - Press a colour key to select one of the colour coded items at the bottom of the screen.
  - Press **P↔P** to return to the previously viewed page.
- 3 Press **Teletext** again to switch Teletext off.

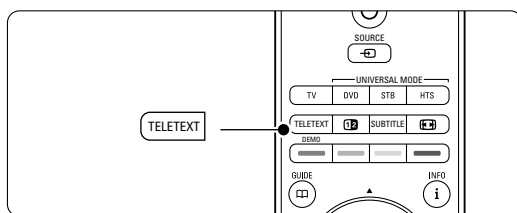

### Note

Only for UK: some digital TV channels offer dedicated digital text services (for example BBC1).

For more information on teletext, see section 5.6 **Teletext**.

## 4.7 Change Ambilight mode

You can adjust the speed at which Ambilight responds to the on-screen images.

### Adjust the Ambilight mode:

- 1** Press **Ambilight** to switch on.
- 2** Press **Mode** to adjust Ambilight between a relaxed and a dynamic setting.

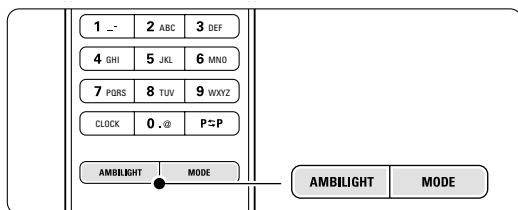

The Mode settings are only available if Ambilight colour is set to Active mode in the Ambilight menu. When a fixed colour has been selected the Mode key has no function. See section **5.5 Ambilight**.

### LoungeLight mode (if available)

When the TV is in standby, you can switch Ambilight on.

- 1** Press **Ambilight**. Wait until Ambilight lights up.
- 2** Press **Mode** repeatedly to toggle through the available Ambilight effects.

For more information on Ambilight, see section **5.5 Ambilight**.

### Tip

Dim lighting conditions in the room for best Ambilight effect.

# 5 Use more of your TV

This section helps you perform advanced TV operations including how to:

- use the menus
- adjust picture, sound and Ambilight settings
- make use of Teletext
- create favourite channel lists



- make advantage of Electronic Programme Guide
- set locks and timers
- set subtitles and select a subtitle language
- view your photos or play your favourite music from a USB memory device or from your PC or Home network.

## 5.1 Remote control

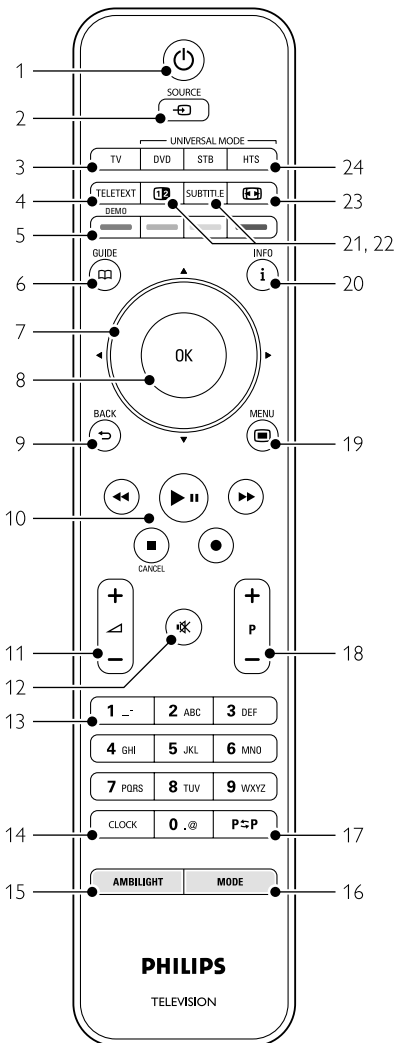
### 5.1.1 Remote control overview



- 1 Standby** To switch the TV on or back to standby.
- 2 Source**
  - To switch the Source menu on or off.
  - To select a connected device or to return to TV.
- 3 TV** Sets the remote control in TV mode.
- 4 Teletext** To switch teletext on or off.
- 5 Colour keys**
  - Easy selection of teletext pages.
  - Easy selection of tasks.
- Demo** To switch the Demo menu on and to get a demonstration of the features of the TV.
- 6 Guide** To switch on or off the Electronic Programme Guide.
- 7 Navigation and rotary key** To navigate (, , , ) or turn left or right to go through lists or settings.
- 8 OK**
  - To display the channel list.
  - To activate a setting.
- 9 Back key** To select the previous programme or the previous TXT page. To remove the channel list.
- 10 Audio and video keys** , , , , To operate a DVD player or recorder, Blu-ray Disc player or VCR.
- Cancel** (only for UK) To cancel only Digital text or Interactive services.
- 11 Volume** To adjust the volume.
- 12 Mute** To mute the sound or restore it.

- 13 **Number keys**  
To select a TV channel.
- 14 **Clock**  
To display the time on screen.
- 15 **Ambilight**  
To switch Ambilight on or off.
- 16 **Mode**  
To adjust the dynamic effect of Ambilight
- 17 **Previous channel P $\rightarrow$ P**  
To return to the previously viewed channel
- 18 **+P- Channel up or down**  
To switch to the next or previous channel in the channel list.
- 19 **Menu**   
To switch the menu on or off
- 20 **On screen information i**  
To show channel or programme information if available.
- 21 **Dual screen**   
To show teletext on the right and the picture on the left of the screen.
- 22 **Subtitle**  
To activate or deactivate the subtitle mode.
- 23 **Widescreen Picture format**   
To select a picture format.
- 24 **DVD STB HTS**  
To control connected devices.

See section **10 Index** to find the section in the manual about a specific remote control key.

### 5.1.2 Universal remote control

Your TV remote control is a universal remote control that can operate other devices such as DVD players and recorders, digital receivers (Set-top boxes – STB) or Home Theatre Systems (HTS) of Philips and many other brands.

- 1** Press **DVD**, **STB** or **HTS** to select a DVD, a cable receiver (STB) or a Home Theatre (HTS) device. The key blinks as long as you are in this control.

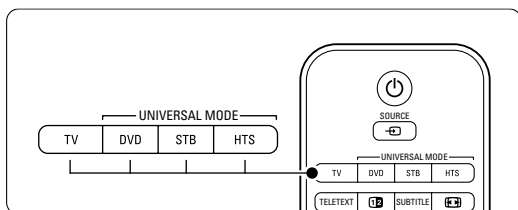

- 2** Use the relevant keys on the TV remote control to operate the device.  
If the device does not react or operates incorrectly, you need to set up your remote control for your particular device.

See section **5.1.3 Set to operate a particular device**.

- 3** Press the **TV** key to return to normal TV mode. When no key is pressed for 30 seconds the remote control switches back to normal TV.

### 5.1.3 Set to operate a particular device

You can choose from three ways to programme the remote control for a device of a particular brand.

You can:

- use the Universal remote control assistant to help you
- enter a brand's setup code or
- start an auto search.

#### **Note**

Possibly the remote control is not compatible with all types of DVD, cable receivers and Home Theatre Systems.

#### **Method 1: Use the Universal remote control assistant**

- 1** Turn on your device.
- 2** Press the **DVD**, **STB** or **HTS** universal mode key for 4 seconds to select the universal mode you need or press **Menu**  and select Setup > Installation > **Remote control assistant** and press  $\blacktriangleright$  to enter:
- **DVD** stands for DVD, DVD-R, HDD and Blu-ray Disc
  - **STB** stands for digital receiver and set-top-boxes (cable, satellite)
  - **HTS** for Home Theatre Systems, Audio/Video systems

The remote control is now in the selected programming mode. Follow the instructions on screen.

#### **Note**

Ensure that the TV and the device are within reach of the remote control.

#### **Method 2: Enter the setup code directly**

Instead of using the Universal remote control assistant, you can also enter a setup code directly. Find a list of these codes per brand and device at the end of this manual.



- 1** Press the **DVD**, **STB** or **HTS** key and **OK** at the same time for 4 seconds to select the universal mode you need.
- 2** Enter the three-number code for the type and brand of your device. Some brands have several setup codes available and you need to select the known one. You can try them one by one.

If you entered a known code, all universal mode keys will blink to confirm the selection. If you entered an unknown code, all universal mode keys will light up for 2 seconds. Repeat Step 2 with a different code.

- 3** Point the remote control at the device, and press  to test if the code is known for your device.  
If successful try whether you can operate all functions. If not successful, or if you cannot operate all functions, repeat Step 1 and 2 with one of the other setup codes for your brand.

### Method 3: Automatic search of all codes

If you are not successful to find the known brand or code, try an automatic search of all codes. The automatic search can take several minutes. If after the automatic search no code is successful, it is not possible to operate your particular device with the remote control. In such case, use the device's own remote control.

- 1** Turn on the device you want the TV remote control to set up for.
- 2** Point the remote control to the device during the automatic search.
- 3** To select the universal mode you need, press the **DVD**, **STB** or **HTS** key and the **OK** key at the same time for 4 seconds.  
The selected universal mode lights up constantly.
- 4** Press **OK** to start the automatic search.  
Every two seconds, when a new code is sent, the  key will blink.  
Keep pointing the remote control to the device.
- 5** When the device switches off, press **OK** to stop the search.
- 6** Press  to switch on your device.
- 7** Press the remote control keys to try if you can operate all functions. If you cannot operate all functions, press **OK** again to continue the automatic search for a correct code.
- 8** If you can operate all functions, press the currently selected universal mode key to confirm and to quit the automatic search.



### Note:

To pause the automatic search, press **OK**. Press **▲** or **▼** to search for the codes one by one backward or forward to locate the known code for your device or press **OK** again to continue the automatic search.

### 5.1.4 Keep the remote control in the chosen universal mode permanently

If you press the **DVD**, **STB** or **HTS** key the remote control can operate other devices. When no key is pressed for 30 seconds the remote control switches back to normal TV.

You can set the remote control to hold a universal mode as long as no other universal mode is pressed. This disables the 30 seconds switch back to normal TV.

- 1** Press the **TV** key.
- 2** Press **OK** and  at the same time for 4 seconds. The  key lights up for 2 seconds.

From now on the remote control will not switch back to normal TV mode.

To return to the 30 seconds switch back to normal TV mode, follow the same steps 1 and 2.

### 5.1.5 Device functions overview

When the remote control is set for a particular device all keys have the same function except the keys mentioned here.

- **DVD player**  
**Menu** key = DVD Disc menu  
**P+/-** = DVD Next/Previous track
- **DVD Recorder**  
**◀◀** key = DVD-R previous track  
**▶▶** key = DVD-R next track
- **DVD recorder with Hard Disc Drive**  
**Menu** key = DVD-R HDD browser  
**◀◀** key = DVD-R HDD previous track  
**▶▶** key = DVD-R HDD next track
- **Blu-ray Disc player**  
 key = BD Content menu  
**Menu** key = BD Disc menu

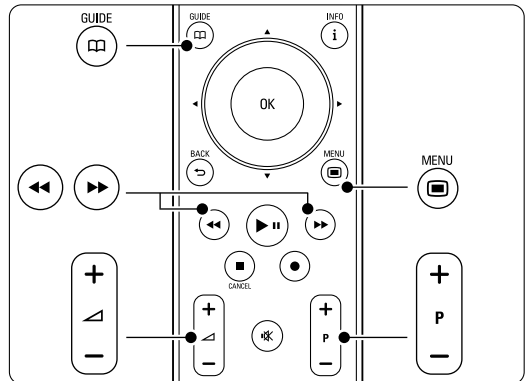



- **Digital or Satellite receiver**  
No change of functions.
- **Home Theatre System**  
Menu key = HTS Disc menu  
◀ key = HTS volume  
P+/- = HTS Next/Previous

### 5.1.6 Remote control setup codes

See the end of this manual.

## 5.2 LightGuide brightness

The LightGuide at the front of the TV indicates the start up of the TV.



After start up the LightGuide is lit constantly. You can set the light intensity or let it switch off after start up.

- 1 Press Menu  > Setup > Installation > Preferences > **LightGuide brightness**.
- 2 Press ▶ to enter the list.
- 3 Press ▲ or ▼ to select the brightness level from 0 (off) to 4.

## 5.3 TV menus

With the on screen menus you install your TV, adjust picture, sound and Ambilight settings and access features. This section gives an overview of the menus and describes how to navigate.

### 5.3.1 The menu

- 1 Press Menu  to show the TV menu.
- 2 Press Menu  to quit the TV menu.

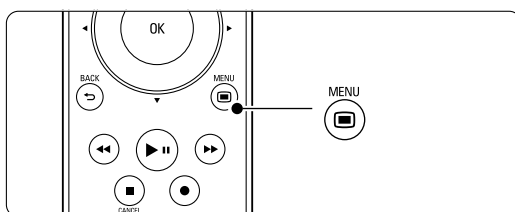

The TV menu offers the following items:

TV menu
Smart settings
<b>Picture</b>
Sound
Ambilight
Settings assistant
Features
Setup

- **Smart settings**  
Select this item to set the TV to one of the predefined settings. Each setting combines picture, sound and Ambilight.
- **Picture**  
Select this menu item to adjust all picture settings.
- **Sound**  
Select this menu item to adjust all sound settings.
- **Ambilight**  
Select this menu item to adjust all Ambilight settings.
- **Settings assistant**  
Use the Settings assistant to guide you through basic picture, sound and Ambilight settings in an easy way.
- **Features**  
Select this item for other feature settings.
- **Setup**  
Select this item
  - for installation and to update the TV software;
  - to make use of the Remote control assistant which will help you to setup your remote control to operate other devices;

- to use the connection assistant which will help you to connect your devices to the TV.

- 6 Press ▲ or ▼ to adjust the setting.
- 7 Press ◀ to return to the Picture settings or press **Menu**  to quit the TV menu.

**Note:**  
More choices come available when digital channels are installed and broadcasted.

### 5.3.2 Use of the menu

Learn to use the menus with this example.

- 1 Press **Menu** .

The TV menu appears on the screen.

TV menu
Smart settings
<b>Picture</b>
Sound
Ambilight
Settings assistant
Features
Setup

- 2 Press ▲ or ▼ to select **Picture**.
- 3 Press ▶ to enter the picture settings.

Picture	Contrast
<b>Contrast</b>	90
Brightness	47
Colour	52
Hue	0
Sharpness	4
Noise reduction	
Tint	
...	

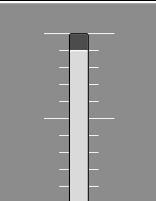

- 4 Press ▼ to select **Brightness**.

Picture	Brightness
Contrast	98
<b>Brightness</b>	47
Colour	52
Hue	0
Sharpness	4
Noise reduction	
Tint	
...	

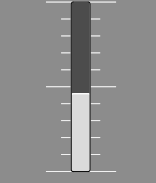

- 5 Press ▶ to enter the brightness setting.



Brightness

## 5.4 Picture and Sound settings

The first time you switched on the TV you have selected your preferred settings for picture, sound and Ambilight. The following sections describe how to modify or read just those settings.

### 5.4.1 Smart settings

Sets the TV to one of the predefined settings. Each setting combines picture, sound and Ambilight.

- 1 Press **Menu**  and select **Smart settings**.
- 2 Press ▶ to enter the list.
- 3 Press ▲ or ▼ to select a setting.
- 4 Press **OK**.
- 5 Press **Menu**  to quit the TV menu.

Smart settings: Personal, Vivid, Standard, Movie, Energy saving, Game.

### 5.4.2 Settings assistant

Use the Settings assistant to guide you through basic picture and sound settings in an easy way.

- 1 Press **Menu** , select Follow the instructions on screen.
- 2 Select **Settings assistant** and press ▶ to enter.
- 3 Press the green key to start the assistant.
- 4 Press ◀ or ▶ to select the left or right side to make your choice.
- 5 When finished, press the green key to store all your settings.

### 5.4.3 Picture settings

This section describes how to adjust all picture settings individually.

- 1 Press **Menu** .
- 2 Select **Picture** and press **▶** to enter the list.
- 3 Press **▲** or **▼** to select a setting.

TV menu	Picture
Smart settings	Contrast
<b>Picture</b>	<b>Brightness</b>
Sound	Colour
Ambilight	Hue
Settings assistant	Sharpness
Features	Noise reduction
Setup	Tint
	<b>Perfect Pixel HD</b>
	Active control
	Light sensor
	Picture format
	Auto format mode

- **Contrast**  
Changes the level of bright parts in the picture but keeps the dark parts unchanged.
- **Brightness**  
Changes the level of light of the total picture.
- **Colour**  
Changes the level of saturation.
- **Hue**  
If NTSC is broadcasted, this level compensates the colour variations.
- **Sharpness**  
Changes the level of sharpness of fine details.
- **Noise reduction**  
Filters out and reduces the noise in the picture. Set the level to Minimum, Medium, Maximum or Off.
- **Tint**  
Sets the colours to Normal, Warm (reddish) or Cool (bluish). Select Custom to make a setting of your own in the Custom menu.
  - **Custom**  
Press the green key to select each bar to change the value of:
    - R-WP red whitepoint
    - G-WP green whitepoint
    - B-WP blue whitepoint
    - R-BL red blacklevel
    - G-BL green blacklevel
- **Perfect Pixel HD**  
Controls the advanced settings of the Perfect Pixel HD Engine, resulting in best sharpness, contrast, colour and motion.

Picture	Perfect Pixel HD
...	HD Natural Motion
Noise reduction	100 Hz Clear LCD
Tint	Advanced sharpn...
<b>Perfect Pixel HD</b>	Dynamic contrast
Active control	Dynamic backlight
Light sensor	MPEG artefact red...
Picture format	Colour enhance...
Auto format mode	

- **HD Natural Motion**  
Removes motion judder and reproduces smooth movement especially in movies.
- **100 Hz Clear LCD** (if present)  
Gives a superior motion sharpness, better black level, high contrast with a flicker-free, quiet image and a larger viewing angle.
- **Advanced sharpness**  
Enables superior sharpness, especially on lines and contours in the picture.
- **Dynamic contrast**  
Sets the level at which the TV automatically enhances the details in dark, middle and light areas of the picture.
- **Dynamic backlight**  
Sets the level at which power consumption can be reduced by dimming the brightness intensity of the screen.  
Choose for the best power consumption or for the picture with the best brightness intensity.
- **MPEG artefact reduction**  
Smooths the digital transitions in the picture.
- **Colour enhancement**  
Makes the colours more vivid and improves the resolution of details in bright colours
- **Active control**  
Corrects all incoming signals in order to provide the best picture possible.  
Switches Active control on or off.
- **Light sensor**  
Adjusts the picture and Ambilight settings on the lighting conditions of the room. Switches Light sensor on or off.
- **Picture format / Auto format mode**  
See section **5.4.4 Widescreen picture format**.

### 5.4.4 Widescreen picture format

Avoid black bars on the sides or on top and bottom of the picture. Change the picture format to a format that fills the screen.

- 1 Press **Picture** to switch on the Picture format menu.

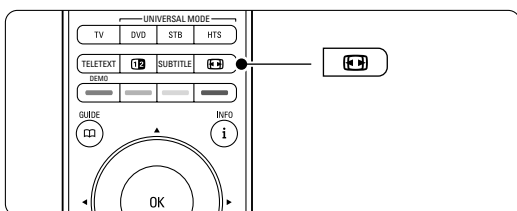

- 2 Press **▲** or **▼** to select an available picture format.
- 3 Press **OK**.
- 4 Press **▲** to shift the picture upwards if subtitles are hidden.

#### Tip

For minimal distortion, select the Auto format setting.

- **Auto format** (Not for PC.)  
Enlarges the picture automatically to fill the screen. Subtitles remain visible. You can set Auto format in two different modes.

- 1 In the TV menu, select **Picture > Auto format mode**.

- 2 Select **Auto-fill** to fill the screen as much as possible. Select **Auto-zoom** to keep the original picture format but black bars may be visible.

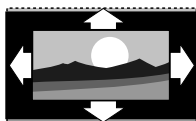

- **Super zoom** (Not for HD.)  
Removes the black bars on the side of 4:3 broadcasts. There is a minimal distortion.

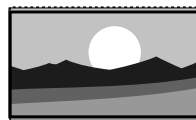

- **4:3** (Not for HD.)  
Shows the classical 4:3 format.

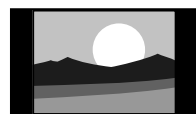

- **Movie expand 14:9** (Not for HD.)  
Scales the format to 14:9.



- **Movie expand 16:9** (Not for HD.)  
Scales the format to 16:9.
- **Wide screen**  
Stretches the format to 16:9.
- **Unscaled** (Only for HD and PC.)  
Maximum sharpness. Distortion may appear on borders. Black bars may appear with pictures from your PC.

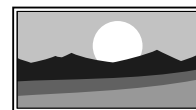
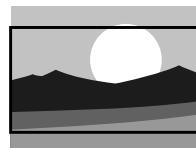

#### Note

Do not forget to name the connection in the Connection menu. See section 7.5.1 Naming your devices.

### 5.4.5 Sound settings

This section describes how to adjust all sound settings.

- 1 Press **Menu** and select **Sound**.
- 2 Press **▶** to enter the list.
- 3 Press **▲** or **▼** to select a setting.

TV menu	Sound
Smart settings	Equalizer
Picture	Volume
<b>Sound</b>	Volume - Visually...
Ambilight	Balance
Settings assistant	Audio language
Features	Dual I/II
Setup	Mono/Stereo
	TV speakers
	Surround mode
	Headphone volume
	Auto volume level...
	Delta volume
	Auto surround

- **Equalizer**  
Changes the bass and treble of the sound. Select each bar to change the setting.
- **Volume**  
Changes the volume. When adjusting the volume with **▲** a volume bar appears. If you do not want it to appear go to **Menu > Setup > Installation > Preferences** and press **▶** to enter the list and select **Volume bar off**.

- **Volume – Visually impaired (UK only)**  
Changes the volume of the selected Visually impaired audio language in the Setup, Installation menu. See section **6.1 Automatic installation**.
- **Balance**  
Sets the balance of the left and right loudspeakers to fit best your listening position.
- **Audio language**  
A list of audio languages for the current programme may be available when digital channels are installed and broadcasted.  
To permanently change the audio language, see section **6 Channel installation**.
- **Dual I/II**  
If broadcasted, you can choose between two different languages.
- **Mono/stereo**  
If stereo broadcasting is available, you can select Mono or Stereo per TV channel.
- **TV speakers**  
If you have connected an audio system to your TV, you can switch off the TV speakers.  
If your audio system supports Easylink, see section **7.2.2 Easylink**.  
Select **Automatic** to have the sound from your TV automatically reproduced by your audio system.
- **Surround mode**  
To select a more spatial sound if broadcasted or if available from a connected device.
- **Headphone volume**  
Changes the volume of the headphone.  
You can mute the TV speakers with  on the remote control.
- **Auto volume levelling**  
Reduces sudden volume differences like at the beginning of commercials or when switching from one channel to another.  
Select on or off.
- **Delta volume**  
Levels out volume differences between channels or connected devices.
  - 1** Switch to the channel or device you want to level out the volume difference.
  - 2** Select **Delta volume** in the Sound menu and change the volume level.
- **Auto surround**  
Switches the TV automatically to the best surround sound mode dependant on the broadcast.  
Select on or off.

## 5.5 Ambilight

You can adjust Ambilight settings.

- 1** Press **Menu**  and select **Ambilight**.
- 2** Press **▶** to enter the list.
- 3** Press **▲** or **▼** to select a setting.

TV menu	Ambilight
Smart settings	Ambilight
Picture	Active mode
Sound	Brightness
<b>Ambilight</b>	<b>Colour</b>
Settings assistant	Separation
Features	
Setup	

- **Ambilight**  
Switches Ambilight on or off.
- **Active mode**  
Adjusts the speed at which Ambilight responds to the on-screen images.  
Only available when Active mode has been selected in the Ambilight colour menu.  
**Relaxed** sets Ambilight to change soft and smoothly with the images on screen.  
**Dynamic** sets Ambilight to change quick and responsive.
- **Brightness**  
Changes the light output of Ambilight.
- **Colour**  
Sets the Ambilight colour to either dynamic behaviour (Active mode) or one of the predefined Ambilight fixed colours.  
**Custom** allows fine tuning of a fixed colour.

Ambilight	Colour
Ambilight	Active mode
Active mode	Warm white
Brightness	Cool white
<b>Colour</b>	<b>Blue</b>
Separation	Custom

- **Separation**  
Sets the difference in colour level between the Ambilights at the sides of the TV.  
Separation off gives a dynamic but uniform colour Ambilight.

### **Caution**

To avoid bad infrared remote control reception, place your devices out of sight of Ambilight.

## 5.6 Teletext

Your TV has a 1200 pages memory that stores broadcasted teletext pages and subpages to reduce waiting time.

To select a teletext page see section 4.6 Select a Teletext page.

### 5.6.1 Select a teletext language

Some digital TV broadcasters offer the possibility to select your preferred teletext language. See section 6.1 Automatic installation.

### 5.6.2 Select paganumber subpages

A teletext page number can hold several subpages. The pages are shown on a bar next to the main paganumber.

- 1 Press **Teletext**.
- 2 Select a teletext page.
- 3 Press **◀** or **▶** to select a subpage.

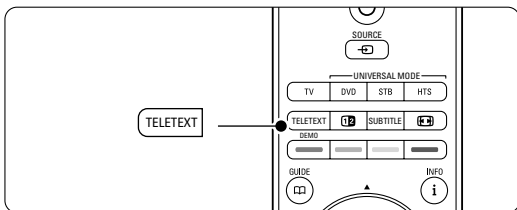

### 5.6.3 Select T.O.P. teletext broadcasts

T.O.P. teletext (Table of Pages) is not broadcast by all TV channels. You can easily jump from one subject to another without using paganumbers.

- 1 Press **Teletext**.
- 2 Press **i**.  
The T.O.P. overview appears.
- 3 Use **◀** or **▶**, **▲** or **▼** to select a subject.
- 4 Press **OK** to view the page.

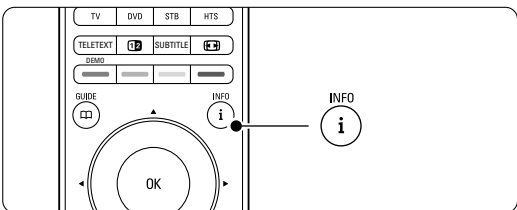

### 5.6.4 Dual screen teletext (not available for channels with Digital Text services)

View the TV channel and teletext next to each other.

- 1 Press **12** for Dual screen teletext.
- 2 Press **Teletext** again to show normal teletext.
- 3 Press **Teletext** to switch off teletext.

### 5.6.5 Search teletext

Quickly jump to a subject linked to a series of paganumbers or search for specific words in teletext pages.

- 1 Press **Teletext**.
- 2 Press **OK** to highlight the first word or number.
- 3 Press **◀** or **▶**, **▲** or **▼** to jump to the next word or number on the page.
- 4 Press **OK** to search a page which holds the highlighted word or number.
- 5 Press **▲** until no word or number is highlighted to quit Search.

### 5.6.6 Enlarge teletext pages

For a more comfortable reading, you can enlarge the teletext page.

- 1 Press **Teletext** and select a teletext page.
- 2 Press **⌂** to enlarge the top part of the page.
- 3 Press **⌂** again to view the enlarged lower part of the page.
- 4 Press **▲** or **▼** to scroll through the enlarged page.
- 5 Press **⌂** again to return to the normal page size.

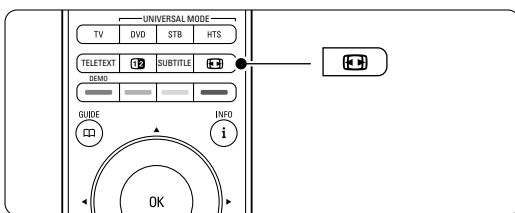

### 5.6.7 Teletext menu

With the options in the teletext menu you can reveal hidden info, let cycle subpages automatically and change the character setting.

- **Reveal**  
Hide or unhide hidden information on a page, such as solutions to riddles or puzzles.
- **Cycle subpages**  
If subpages are available for the selected page, you can make subpages cycle automatically.

- **Language**

Some languages use a different set of characters. Switch to the other group to show the text correctly.

- 1 Press **Teletext**.
- 2 Press **Menu** .

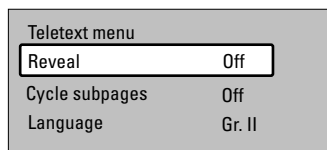

- 3 Press **▲** or **▼** to select an option.
- 4 Press **OK** to change a setting.
- 5 Press **Menu**  to quit the teletext menu.
- 6 Press **Teletext** to switch off teletext.

### 5.6.8 Digital text services (UK only)

Some digital TV broadcasters offer dedicated digital text or interactive services (for example BBC1) on their digital TV channels. These services work as normal Teletext with the number, colour and navigation keys to select and navigate.

- 1 Press **Teletext**.
- 2 Press **◀** or **▶**, **▲** or **▼** to select or highlight items.
- 3 Press one of the colour keys to select an option.
- 4 Press **OK** to confirm or activate.
- 5 Press **■ Cancel** to cancel Digital text or interactive services.

#### **Caution**

Digital text services are blocked when subtitles are broadcasted and Subtitle On is set in the Features menu. See section **5.10 Subtitles**.

### 5.6.9 Teletext 2.5

If broadcasted by the TV channel this teletext offers more colours and better graphics.

Teletext 2.5 is switched on as a factory setting.

- 1 Press **Menu**  on the remote control and select Setup > Installation > Preferences > **Teletext 2.5** and press **▶** to enter the list.
- 2 Select on or off.

## 5.7 Create favourite channel lists

View the All channels list or set up a Favourite list of your own with your preferred TV channels and radio stations.

### 5.7.1 Select a favourite list

You can select one of the favourite channel lists.

- 1 Press **OK**.

The first time after you have finished the installation, the All channels list is shown. In other situations, it brings up the last selected favourite list.

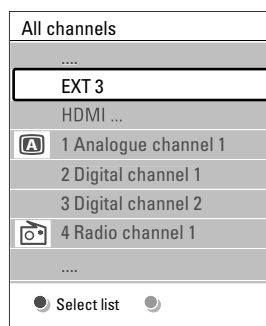

- 2 Press the red key to show all favourite lists.
- 3 Press **▲** or **▼** to select a list.
- 4 Press **OK**.  
The selected favourite list appears.
- 5 Press **OK** again to quit.

### 5.7.2 To set up a favourite list

Create or modify your own favourite list.

- 1 Press **OK**.  
The last selected list appears.
- 2 Press the red key to show all favourite lists.
- 3 Press **▲** or **▼** to select a list.
- 4 Press **OK**.
- 5 Press the green key to enter the Edit mode.  
The selected list brings up a full channel list.
- 6 Press **▲** or **▼** to highlight a channel.
- 7 Press **OK** to mark (or unmark) the highlighted channel. The channel is added to (or removed from) the selected list.
- 8 Press the green key again to leave the Edit mode.  
The modified channel list appears again.

### 5.7.3 Select a channel from a favourite list

- 1 Press OK.  
The last selected channel list appears.
- 2 Use ▲ or ▼ to highlight a channel.
- 3 Press OK.  
The TV tunes to that channel.

#### Tip

- Use -P+ to go through the TV channels of the selected favourite list.
- With the number keys you can still select channels which are not marked as favourite.

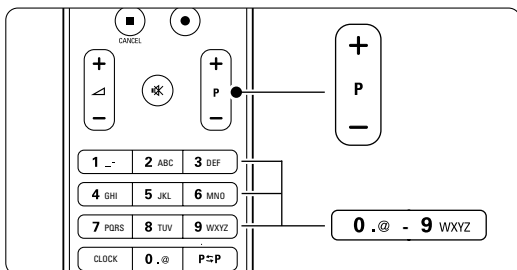

## 5.8 Electronic Programme Guide - EPG -

The Electronic Programme guide is an on screen guide to scheduled digital TV programmes. You can navigate, select and view programmes by time, title or genre. There are two types of EPG, 'Now and Next' and '7 or 8 day' EPG.

When digital channels are installed and broadcasted, EPG is available. 'Now and Next' is always available but the '7 or 8 day' EPG is only available in some countries.

With the EPG menu you can...

- see a list of current broadcasted programmes
- see the next programme
- group programmes by genre
- set reminders when programmes will start
- set up preferred EPG channels
- etc.

### 5.8.1 Switch on EPG

- 1 Press .

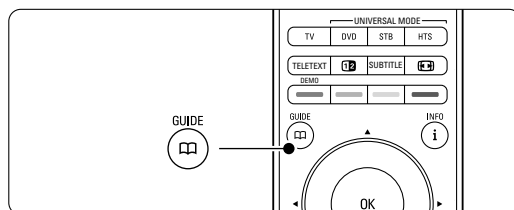

The following type of EPG appears:

#### 'Now and Next' EPG

Detailed information about the current programme is shown.

26 BBC1	Tue., 12 Sep	09:17
Title : Commonwealth Games		
Info: 7:50 - 12:30 : 280 min .....		
Exit	Next	
Press -P+ to change channel.		

Or

#### '7 or 8 day' EPG

It may take some time to receive the EPG data. The list of TV programmes will show.





## 5.9 Timers and locks

This section describes how to switch the TV on or off at a specified time and to lock or unlock the TV.

### 5.9.1 Automatically switch to standby



Sleeptimer switches the TV to standby after a time.

- 1 Press **Menu**  on the remote control and select **Features > Sleeptimer** and press **▶** to enter the sleeptimer bar.
- 2 Press **▲** or **▼** to set the time up to 180 minutes in steps of 5 minutes. If set to 0 minutes, the Sleeptimer is switched off.

You can always switch off your TV earlier or reset the time during countdown.

### 5.9.2 Automatically switch the TV on

On timer switches the TV on automatically to a specified channel at a specified time, from standby.

- 1 Press **Menu**  on the remote control and select **Features > On timer** and press **▶** to enter the On timer menu.
- 2 Use **◀** or **▶**, **▲** or **▼** to select and enter the menu items one by one to set a channel, a day of the week or daily, and a starting time.
- 3 Press **OK** to confirm.
- 4 Press **Menu**  to quit the menu.

#### **Tip**

To switch off the On timer, select **Off** in the On timer menu.

### 5.9.3 Lock TV channels and programmes

Lock TV channels and/or programmes from connected devices to prevent children from watching them. Lock and unlock with a four number code.

#### Set or change your code

- 1 Press **Menu**  on the remote control and select **Features > Set or Change code** and press **▶** to enter your code.
- 2 Enter your code with the number keys.  
The **Features** menu reappears with a message confirming that your code has been created or changed.

#### Did you forget your code ?

- 1 Select **Change code**.
- 2 Press **▶**.

- 3 Enter the overriding code 8-8-8-8.

- 4 Enter a new personal code.

- 5 Confirm your new entered code.

The previous code is erased and the new code is stored.

### 5.9.4 Activate or deactivate Child lock

Set your code and you can:

- Lock all channels and devices,
- Lock specific channels and devices,
- Set a time after which all channels and devices are locked,
- Set the maximum allowed parental rating for digital channels that are installed and broadcast.

- 1 Press **Menu** .
- 2 Select **Features > Child lock** and press **▶**.
- 3 Enter your code with the number keys.
- 4 Select one of the options.
- 5 Press **▶**.

#### Lock or unlock all channels and connected devices

- 1 Select **Lock** or **Unlock**.

#### Lock a certain programme or all channels from a certain time

Child lock	Custom lock
Lock	Lock after
Custom lock	Channel lock
Unlock	Parental rating

- 1 Select **Custom lock**.
- 2 Press **▶** to enter the Custom lock menu.
- 3 Press **▶** again to enter the Lock after menu.
- 4 Select **On** to switch on the Timer lock.
- 5 Press **◀**.
- 6 Select **Time**.
- 7 Press **▶**.
- 8 Enter the time with **▲** or **▼** and **▶**.
- 9 Press **OK**.

#### Lock one or more channels and connected devices

- 1 Select **Custom lock**.
- 2 Press **▶** to enter.
- 3 Press **▲** or **▼** to select **Channel lock**.
- 4 Press **▶**.
- 5 Press **▲** or **▼** to select the channel(s) you want to lock or unlock.
- 6 Each time press **OK** to lock or unlock the channel.

### Set an age rating to a digital programme

Some digital broadcasters have their programmes rated (depending on your country). When the rating is higher than your child's age, the programme will be locked.

- 1 Select **Custom lock**.
- 2 Press **▶** to enter.
- 3 Press **▲** or **▼** to select **Parental rating**.
- 4 Press **▶**.
- 5 Press **▲** or **▼** to select an age rating.
- 6 Press **Menu**  to quit the Child lock menu.

## 5.10 Subtitles

For each TV channel, subtitles can be set, coming from Teletext or DVB-T (digital) broadcasts. If digital channels are installed and broadcasted, you can select your preferred subtitle language.



### 5.10.1 Subtitling from analogue TV channels

- 1 Select an analogue TV channel.
- 2 Press **Teletext** to switch on Teletext.
- 3 Enter the three number pagenummer of the subtitle page.
- 4 Press **Teletext** to switch off Teletext.

#### Note

The Teletext subtitle page of analogue channels must be stored for each TV channel separately.

### 5.10.2 Activate or deactivate subtitling

- 1 Press **Menu**  on the remote control and select **Features** > **Subtitle** and press **▶** to enter the list.
- 2 Press **▲** or **▼** to select **On** to show the subtitles always or **On during mute** to show the subtitles only when the sound is muted with the  key on the remote control.
- 3 Press **◀** to return to the Features menu.

TV menu	Features
Smart settings	Common interface
Picture	Subtitle
Sound	Subtitle language
Ambilight	Sleeptimer
Settings assistant	Child lock
<b>Features</b>	Set/Change code
Setup	On timer
	Demo

### 5.10.3 Select a digital subtitle language

If subtitle broadcasting is available with digital channels, you can select a preferred subtitle language out of a list of broadcasted languages. The preferred subtitle languages set in the Installation menu are overruled temporarily.

- 1 Press **Menu**  on the remote control and select **Features** > **Subtitle language** and press **▶** to enter the list of available languages.
- 2 Press **▲** or **▼** to select a subtitle language.
- 3 Press **OK**.

## 5.11 Watch and play your photos and music

Watch pictures or listen to music stored on a USB device (not supplied with the TV), a camcorder (only for photos) or from your PC network. Watch your pictures as a slideshow or listen to a self made music playlist.

#### Note

Philips is not responsible if your USB device is not supported nor shall Philips accept any liability for damage or loss of stored data.

### 5.11.1 Insert the USB device

- 1 Insert a device at the side of the TV while the TV is switched on.  
A message appears that a USB device has been detected.

#### Note

In case the USB device does not automatically break in, press **Source**  > **USB/Memory devices** and press **OK**.  
Select **Side** and press **OK** to display your camcorder content.

### 5.11.2 Remove the USB device

- 1 Press **Source** .
- 2 Remove the USB device.
- 3 Select **TV** or another connected device to watch a programme.

### 5.11.3 Watch your pictures, start a slideshow and play music

Look up your pictures in the Picture album of your USB device.

- 1 Select the Picture folder for the picture files you have stored on your USB device.

USB	Picture
Picture	Afrika_2001
Music	Paris_2006
	My_car.jpg
	Jean.jpg
	Mary.jpg

- 2 Press **▶** to enter the Picture folder.
- 3 Press **▲** or **▼** to select a picture or a picture album.

Picture	Afrika_2001
Afrika_2001	Kenya.jpg
Paris_2005	Congo.jpg
My_car.jpg	Victoria.jpg
Jean.jpg	Dakar.jpg
Mary.jpg	Cairo.jpg

Afrika_2001	Afrika_2001
Kenya.jpg	
Congo.jpg	
Victoria.jpg	
Dakar.jpg	
Cairo.jpg	

- 4 Press **OK** to watch the picture or to start a slideshow of the pictures in the album.
- 5 Press **OK** to pause the slideshow. Press again to restart.
- 6 Press one of the colour keys on the remote control to perform the corresponding function shown at the bottom of the screen.  
If the function bar at the bottom disappeared, press any colour key to let it reappear.
- 7 Press **◀** and select another picture or another album.

#### Slideshow settings

##### • Details / More details

Shows the picture name, date, size and next picture in the slideshow.

##### • Transitions

Shows the list of available transition styles of the pictures.

Press **▲** or **▼** to select and press **OK** to activate.

##### • Slide time

Sets the time lag for the picture transitions:  
Short, Medium or Long.

##### • Rotate

To rotate a picture.





##### • Start/Show/Pause

To stop, pause and restart the slideshow.

#### Thumbnails

Watch the pictures of a selected album in an overview.

- 1 Select a picture album.
- 2 Press **▶** to enter the picture list.
- 3 Press the blue key.
- 4 Press **▲** or **▼**, **◀** or **▶** to highlight a picture.
- 5 Press **OK** to watch the picture.
- 6 Press **◀** to return to the thumbnail overview.
- 7 Press the blue key again to go back to the picture list.

USB	Afrika_2001	Kenya.jpg
		
		

#### Listen to music

Look up your songs in the Music album of your USB device.

- 1 Select the Music folder for the music files you have stored on your USB device.
- 2 Press **▶** to enter the Music folder.
- 3 Press **▲** or **▼** to select a song or a music album.
- 4 Press **OK** to play the selected song or to play a song followed by the next song in the same album.
- 5 Press one of the colour keys on the remote control to perform the corresponding function shown at the bottom of the screen.  
If the function bar at the bottom disappeared, press any colour key to let it reappear.

#### Music settings

##### • Details

Shows the file name.

##### • Repeat one/all

Repeat all songs in the album until you stop a song or only repeat the one song selected until you stop the song.

##### • Shuffle

Play songs in a random sequence.

---

### Watch a slideshow with background music

Watch a slideshow of your stored pictures accompanied with your stored background music.

- 1** Select an album of songs first and press **OK**.
- 2** Highlight the Picture folder and select an album of pictures and press **OK**.

---

### 5.11.4 Watch photos or listen to music from your PC

To watch photos and listen to music from a connected PC, make sure:

- your router and PC are switched on
- a media server software is running on your PC.

See section **7.7 PC network**.

- 1** Press the **Source**  key on the remote control.
- 2** Select **PC network** and press **▶**.  
Wait until the PC content comes on.
- 3** Select the content you want to watch or listen to and press **▶**.
- 4** Use **◀** or **▶**, **▲** or **▼** to go through the photo or music files or folders.
- 5** Press **OK** to watch or listen.
- 6** Press **◀** to go back to the previous list.

See section **9 Troubleshooting** in case of problems playing files or in case your PC does not appear in the PC network menu.

---

## 5.12 Listen to digital radio channels

If digital broadcasting is available, digital radio channels are installed during installation.

To listen to a digital radio channel:

- 1** Press **OK** on the remote control.  
The **All channels** menu is displayed.
- 2** Use the number keys to select a radio channel available from channel number 400 onwards.  
To reorder see section **6.3.3 Reorder the channels**.
- 3** Press **OK**.

## 5.13 Software update

Philips continually tries to improve its products. To benefit, update the TV software regularly. To update your TV software you need a USB Memory device (not supplied).

Verify that your USB memory device has at least 128Mb free space. Make sure the write protection is switched off. Some USB devices do not work with our TV.

### 5.13.1 Update assistant

The Update assistant helps you to update the TV's software.

#### Step 1: TV identification

The TV has to identify with your USB memory device.

- 1 Press **Menu**  > **Setup**.
- 2 Press **▶**.
- 3 Press **▲** or **▼** to select **Software update**.
- 4 Press **▶**.

Setup	Software update
Installation	Update assistant
<b>Software update</b>	Current software ...
	Local updates
	Announcement

- 5 Press **▲** or **▼** to select **Update assistant**.
- 6 Press **▶**.
- 7 Press **OK** to activate.
- 8 Insert a USB memory device into the USB connector at the side of the TV.  
The TV menu appears.
- 9 Press the green key to proceed.  
A message appears that the TV has successfully written its identification file to the USB memory device.
- 10 Press the green key again to finish.
- 11 Remove the USB memory device from the TV.

#### Step 2: Software download from the PC to the USB device

- 1 Insert the USB memory device into a PC linked to the internet.
- 2 Locate and open the file **update.htm** on your USB device.
- 3 Read the instructions on screen and click on the **Send ID** button.  
If new software is available, the update is downloaded on the USB memory device.
- 4 Remove the USB memory device from your PC.

#### Step 3: Software update transfer to the TV

The downloaded software on the USB memory device must now be uploaded to your TV.

#### ⚠ Caution

- Never remove the USB memory device from the TV during the software update.
- If a power drop occurs during the update, do not remove the USB memory device from the TV. When the power returns, the TV continues to update.

- 1 Switch on the TV.
- 2 Insert the USB memory device to the USB connector at the side of the TV.

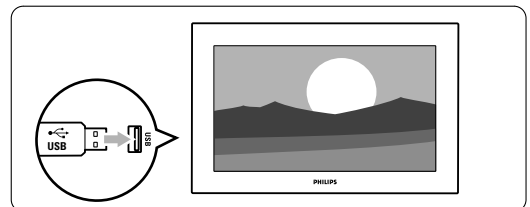

- 3 The TV switches off. The screen stays black for about 10 seconds. Wait and do not use the power switch  on the TV.

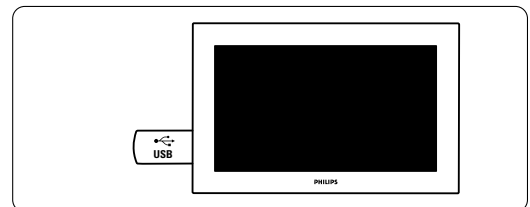

- 4** The update process starts automatically. Please wait.

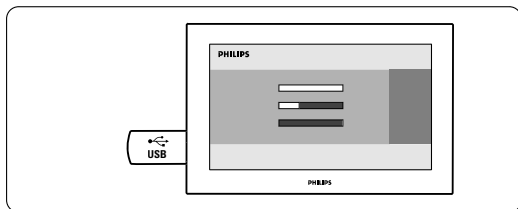

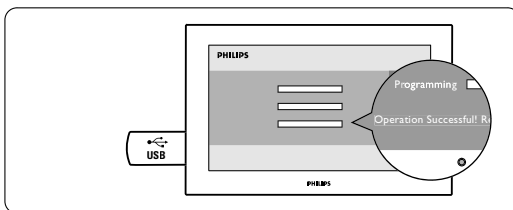

The update is finished when the message 'Operation successful' appears on the screen.

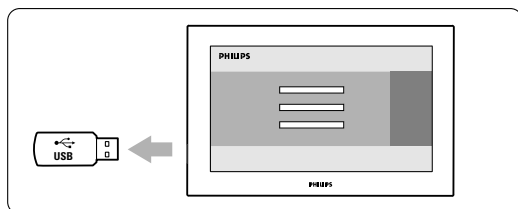

- 5** Remove the USB memory device from the TV.



- 6** Press  on the remote control. Do not press more than once and do not use the **Power**  switch on the TV.

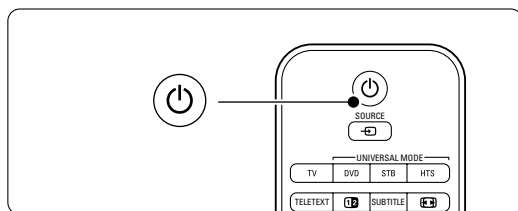

- 7** The TV switches off. The screen stays black for about 10 seconds. Please, wait.

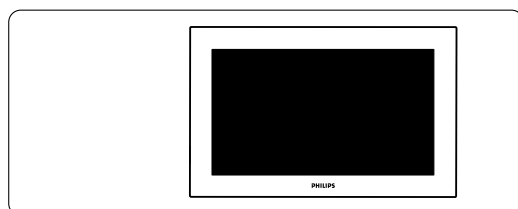

- 8** The TV switches back on again. The update is done.

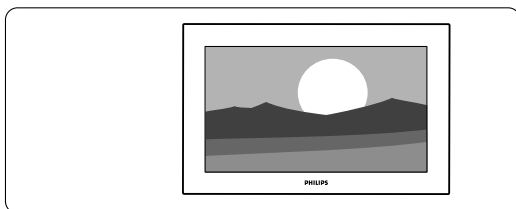

### 5.13.2 Software update by digital broadcast (DVB-T)

Your TV might receive new software from the digital broadcast system automatically.

If you receive an update message on screen it is strongly advised to update the software immediately - select **Now**.

If you want to be reminded later on, select **Later**.

Select **Cancel** to quit the update (not recommended). If you cancelled the update you can still update yourself from the TV menu > Setup > Software update > Local updates.

## 6 Channel installation

The first time you turned on your TV

- you have selected the language of the TV menus and the country where you are located
  - all the available TV Channels have been installed.
- This chapter provides instructions on how to reinstall channels as well as other useful channel installation features.

### Note:

Re-installation will modify the All channels list and new added channels will not be added to any favourite list.

### 6.1 Automatic installation

This section describes how to search for and store all available channels automatically.

#### Step 1: Menu language

Sets the language of the TV menus. Go to a next step if your language settings are correct.

- 1 Press **Menu**  on the remote control and select Setup > Installation > **Languages** and press **▶** to enter **Menu language**.
- 2 Press **▲** or **▼** to select your language.
- 3 Press **OK** to confirm.
- 4 Press **◀** to return to the Installation menu.

Installation	Languages
Languages	Menu language
Channel install...	Primary audio
Preferences	Secondary audio
Rem. contr. assist.	Primary subtitles
Connections assist.	Secondary subtitl.
Rename devices	Primary teletext
Audio setup	Secondary teletext
...	Hearing impaired
	Visually impaired
	Pref. audio format

The Languages menu also offers the following language settings when digital channels are installed and broadcasted.

- **Preferred audio language**  
Select one of the available audio languages as primary preferred and secondary preferred language.
- **Preferred subtitle languages**  
Select one of the available subtitle languages as primary preferred and secondary preferred language. See section **5.10 Subtitles**.

- **Preferred teletext languages**  
Select one of the available teletext languages as primary referred and secondary preferred language.
- **Hearing impaired**  
Select **On** to display the hearing impaired subtitle version of your preferred audio or subtitle language when available.
- **Visually impaired (UK only)**  
Select to hear the additional commentary audio (if available) in your selected audio language through the loudspeakers of your TV or through the headphones or through both

### Note:

If both Visually impaired and Hearing impaired are enabled, the Visually impaired language will have priority for audio, the Hearing impaired for subtitles.

- **Preferred audio format**

Select your preferred and available audio format to achieve the best sound reproduction. Select **Advanced** for the best sound reproduction if a Home theatre system is connected to your TV. Select **Standard** in all other cases.

#### Step 2: Select your country

Select the country where you are located. The TV will install and arrange the TV channels according to the country selected. Go to a next step if your country selection is correct.

- 1 Press **▼** to select **Channel installation**.
- 2 Press **▶** to enter the Channel installation menu. **Automatic installation** is highlighted.
- 3 Press **▶** to enter.
- 4 Press **OK**.  
The Country list appears.
- 5 Press **▲** or **▼** to select your country.
- 6 Press **Next**.

Channel install...	Automatic install...
Automatic install...	Start now
Installation update	
Start-up message	
Digital: Test recept...	
Analogue: Manual...	
Rearrange	



### Step 3: Select Antenna or Cable

This selection is only available when this TV is prepared to receive DVB-C channels in your country.

Select **Antenna** to install all digital terrestrial (DVB-T) and analogue channels available.

Select **Cable** to install all digital cable (DVB-C) and analogue channels available.

- 1 Press ▲ or ▼ to select **Antenna** or **Cable**.
- 2 Press **Next**.
- 3 If the TV asks for it, enter the Network ID you received from your provider.

#### Note

You can do a Channel installation if you are both connected to a digital antenna and a cable network. Therefore do the installation twice. To watch the stored Antenna channels or the stored Cable channels, you will have to switch between Antenna or Cable in the Channel installation > Antenna or Cable menu.

### Step 4: Install TV and radio channels

Your TV will search for and store all available digital and analogue TV channels and all available digital radio channels.

If you selected Cable in Step 3, a Settings menu is available. Leave these settings unchanged unless your provider supplied specific values to use for Network frequency, Network ID or Symbol rate. Follow the text on screen to change the settings. Use the digit keys to enter the numbers. You can also select to install analogue channels or not.

- 1 Select **Start**.  
The installation may take a few minutes.  
In case of Cable selection, the TV can ask to enter the Network ID supplied by the cable provider. Enter this ID with the digit keys.
- 2 When the installation is done, press **Finish** to return to the Channel installation menu.
- 3 Press **Menu**  to quit the menu.

#### Tip

When digital channels are found, the list of installed channels may show some empty channel numbers. If you want to rename, reorder or uninstall stored channels, see section **6.3 Rearrange channels**.

### Step 5 Clock, time zone and daylight saving selection

Only available when the country selected supports digital broadcasts.

Go to a next step if this step is not applicable.

- 1 Press ▼ to select **Clock**.
- 2 Press ► to enter.
- 3 Press ▲ or ▼ to select **Auto clock mode**.
- 4 Press ► to enter.

Installation	Clock
...	Auto clock mode
Connections assist.	Time zone
Rename devices	Daylight saving
Audio setup	
Decoder	
Man. network inst.	
<b>Clock</b>	
Factory settings	

#### Auto clock mode

Select **Automatic** to instruct your TV to always get the time correctly. Time zone and Daylight saving correction are automatically set.

Select **Manual** when Universal Time Coordinated (UTC) is not available in your area.

#### Time zone/Daylight saving

When you selected Auto clock mode manually, select your local time zone and choose between **Standard** (winter) and **Daylight saving time** (summer).

## 6.2 Analogue: Manual installation

You can tune-in analogue TV channels channel by channel manually with Manual installation.

### 6.2.1 Select the system

- 1 Press **Menu**  and select Setup > Installation > Channel installation > **Analogue: Manual installation**.
- 2 Press **▶** to enter the Manual installation menu. **System** is highlighted.
- 3 Press **▶** to enter the System list.
- 4 Press **▲** or **▼** to select your country or part of the world where you are now located.
- 5 Press **◀** to return to the Manual installation menu.

Channel install...	Analogue: Manual...
Automatic install...	System
Installation update	Search
Start-up message	Fine tune
Digital: Test recept...	Store current ch...
Analogue: Manual...	Store as new ch...
Rearrange	

### 6.2.2 Search for and store a new channel

- 1 Press **Menu**  and select Setup > Installation > Channel installation > Analogue: manual installation > **Search**.
- 2 Press **▶** to enter the Search menu.
- 3 Press the red key to enter the frequency yourself or press the green key to search for a next channel.



#### **Tip**

If you know the frequency, enter the three numbers of the frequency with the number keys of the remote control.

- 4 Press **◀** when the new channel has been found.
- 5 Select **Store as new channel** to store the new channel under a new channel number.
- 6 Press **▶** to enter.
- 7 Press **OK**.  
**Done** appears.
- 8 Press **Menu**  to quit the channel installation menu.

### 6.2.3 Fine tune a channel

Fine tune a found channel when the reception is poor:

- 1 Press **Menu**  and select Setup > Installation > Channel installation > Analogue: manual installation > **Fine tune**.
- 2 Press **▶** to enter the Fine tune menu.
- 3 Press **▲** or **▼** to adjust the frequency
- 4 Press **◀** when you finished fine tuning.
- 5 Select **Store current channel** to store the fine tuned channel under the current channel number.
- 6 Press **▶** to enter.
- 7 Press **OK**.  
**Done** appears.
- 8 Press **Menu**  to quit the Channel installation menu.

## 6.3 Rearrange stored channels

To rename, reorder, uninstall or reinstall stored channels.

### 6.3.1 Rename a channel

Assign or change a channel name to a channel for which a name has not yet been entered.

- 1 Press **Menu**  and select Setup > Installation > Channel installation > **Rearrange**.
- 2 Press **▶** to enter the channel list.
- 3 Press **▲** or **▼** in the channel list to select the channel you want to rename.
- 4 Press the red key.
- 5 Press **◀** or **▶** to select a character or **▲** or **▼** to change the characters. Space, numbers and other special characters are located between **z** and **A**.
- 6 Press the green key or **OK** to finish.

#### **Tip**

To delete all characters, press the yellow key.  
To delete the highlighted characters, press the blue key..

### 6.3.2 Uninstall or reinstall a channel

To uninstall a stored channel so that it is no longer possible to tune to.



Reinstall an earlier uninstalled channel.

- 1 Press **Menu**  and select Setup > Installation > Channel installation > **Rearrange**.
- 2 Press **▶** to enter the channel list.

- 3 Press ▲ or ▼ in the channel list to select the channel you want to uninstall or reinstall.
- 4 Press the green key to uninstall or reinstall the channel.
- 5 Press **Menu**  to quit the menu.

### 6.3.3 Reorder the channels

Change the order of the stored channels.

- 1 Press **Menu**  and select Setup > Installation > Channel installation > **Rearrange**.
- 2 Press ► to enter the channel list.
- 3 Press ▲ or ▼ in the channel list to select the channel you want to reorder.
- 4 Press the yellow key to move up the highlighted channel in your channel list.
- 5 Press the blue key to move down the highlighted channel in your channel list.
- 6 Press **Menu**  to quit the menu.

## 6.4 Channel management

### 6.4.1 Automatic search



Once a day, at 3 AM, the TV searches for all available TV channels automatically. Leave your TV in standby.

Earlier found channels are updated and new channels are stored. Channels not found by the search anymore are removed from the channel list. When Channel management has found or removed channels, a message at TV start up is shown. You can activate or deactivate this message.

- 1 Press **Menu**  and select Setup > Installation > Channel installation > **Startup message**.
- 2 Select On or Off.

### 6.4.2 Manual search

You can install the updates at any time.

- 1 Press **Menu**  and select Setup > Installation > Channel installation > **Installation update**.
- 2 Press ► to enter the Installation update menu.
- 3 Press **OK**.
- 4 Press the green key to start.  
The update starts and may take a few minutes.
- 5 When the update is completed, press the red key to return to the Channel installation menu.
- 6 Press **Menu**  to quit the menu.

## 6.5 Digital reception test

If you receive Digital TV broadcasting you can verify the quality and signal strength of a specific channel.



- 1 Select a channel.
- 2 Press **Menu**.
- 3 Select Setup > Installation > Channel installation > **Digital:Test reception**.
- 4 Press ► to enter
- 5 Press **OK**.
- 6 Press the green key to start the test.  
Information on the quality and the signal strength of this channel is shown.
- 7 Use the cursor keys to change the frequency to improve the signal or enter a new frequency directly with the digit keys.
- 8 Press the green key to store the frequency if the signal quality and strength are good.
- 9 Press the red key to return to the Channel installation menu.
- 10 Press **Menu** to quit the menu.

### Tip

To achieve the best results, contact a specialised antenna installer.

## 6.6 Factory settings

You might want to return to the original factory settings. Only picture, sound and Ambilight settings will be reset.

- 1 Press **Menu**  and select Setup > Installation > **Factory settings**.
- 2 Press ► to enter the Factory settings menu.
- 3 Press **OK**.
- 4 Press **Menu**  to quit the menu.

# 7 Connections

## 7.1 Connection overview

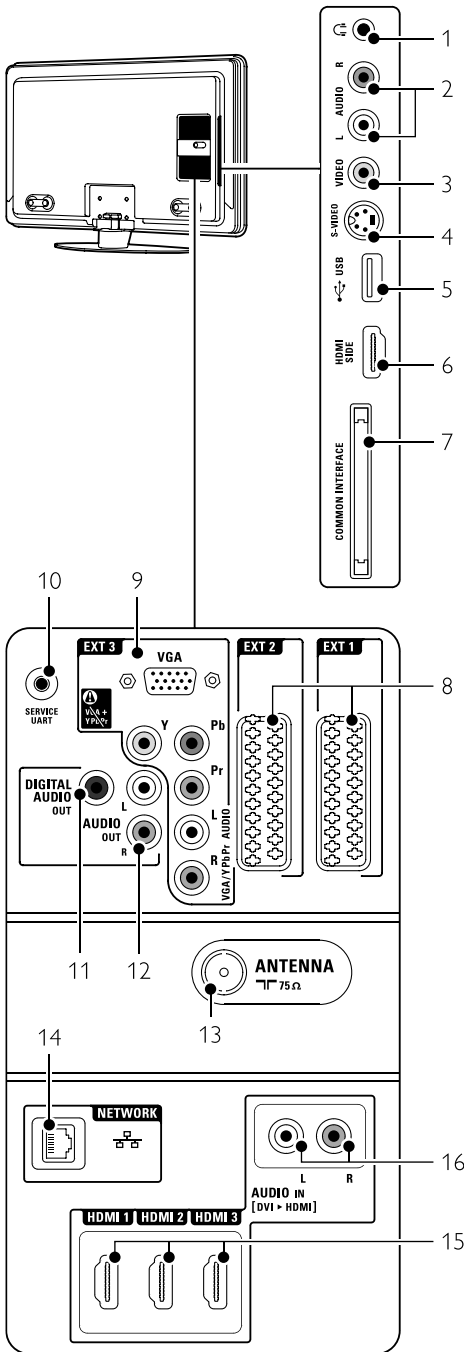

### Side connectors

- 1 **Headphones**  
Stereo Mini jack
- 2 **Audio L/R**  
Audio L/R input to be used together with Video or S-Video on the side of the TV.
- 3 **Video**  
Video input to be used together with the Audio L/R on the side of the TV.
- 4 **S-Video**  
S-Video input to be used together with the Audio L/R on the side of the TV.
- 5 **USB**  
USB connector.
- 6 **HDMI Side**  
HDMI input
- 7 **Common interface**  
Slot for Conditional Access Modules (CAM)

### Back connectors

- 8 **EXT1, EXT2**  
Scart connectors for DVD, VCR, Digital receiver, Game console, etc.
- 9 **EXT3**  
Component Video Y Pb Pr and Audio L/R connectors for DVD, Digital receiver or Game console, etc.  
VGA and Audio L/R connectors for a PC.
- 10 **Service UART**  
For service only.
- 11 **Digital Audio Out**  
Sound output cinch connector for a Home Theatre System, etc.
- 12 **Audio Out L/R**  
Sound output cinch connectors for a Home Theatre System, etc.
- 13 **Antenna input**
- 14 **Network**  
Home network connector.
- 15 **HDMI 1, HDMI 2, HDMI 3**  
HDMI input connectors for Blu-ray Disc player, HD Digital receiver or HD Game console, etc.
- 16 **Audio L/R In [DVI to HDMI]**  
Audio In L/R connectors to be used together with a DVI to HDMI connection.

## 7.2 About connections

### 7.2.1 What you need to know

Connect your device with the highest possible quality connection.

Look for the highest quality connection on your device. Use that connection to your TV.

#### HDMI - Highest quality ★★★★★

An HDMI connection has the best picture and sound quality. One cable combines video and audio signals. Use HDMI for HD (High Definition) TV signals. HDMI with EasyLink offers easy operating of your connected devices when these have the HDMI CEC standard. See section 7.2.2 EasyLink. A device connected with HDMI to the TV can only send out audio and video signals to your TV. The device cannot receive or record audio and video from your TV.

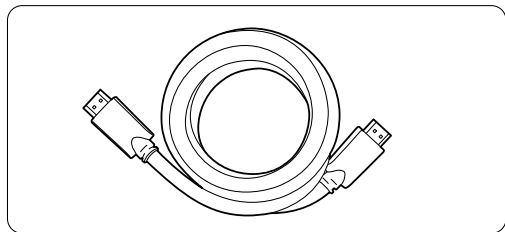

HDMI cable (max. 5m)

#### ⊕ Tip

##### DVI to HDMI – Higher quality ★★★★★

Use a DVI to HDMI adaptor if your device has only a DVI connection.

Connect an Audio L/R cable to Audio In L/R (DVI to HDMI) for sound.

Assign this Audio In to the HDMI 1, 2 or 3 where the device is connected. See section 7.5.2 Audio setup (if present).

#### ⊖ Note

HDMI supports HDCP (High-bandwidth Digital Contents Protection). HDCP is a copy protection signal that comes with HD content (DVD disc or Blu-ray Disc).

#### YPbPr – Higher quality ★★★★★

Use the Component Video YPbPr connections together with Audio Left and Right. Match the cable colours when you connect.

YPbPr can handle HD TV signals.

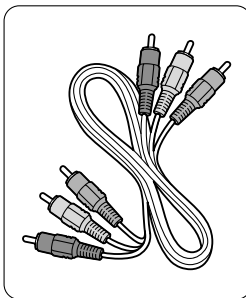

Component Video YPbPr cable  
- Red, Green, Blue

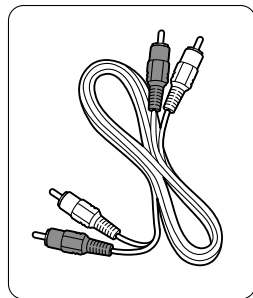

Audio L/R cable  
- Red, White

#### Scart - Good quality ★★★

One cable combines video and audio signals.

Scart connectors can handle RGB video but no HD TV signals.

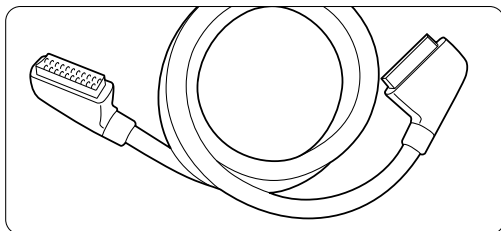

Scart cable

#### S-Video - Good quality ★★

Use an S-Video cable together with an Audio L/R (cinch) cable. Match the cable colours when you connect.

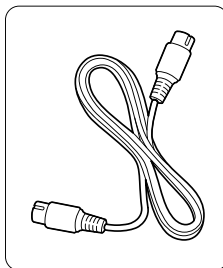

An S-Video cable

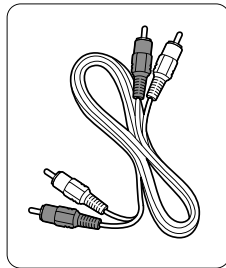

Audio L/R cable  
- Red, White

---

### Video - Basic quality ★

Use a Video (cinch) cable together with an Audio L/R (cinch) cable. Match the cable colours when you connect.

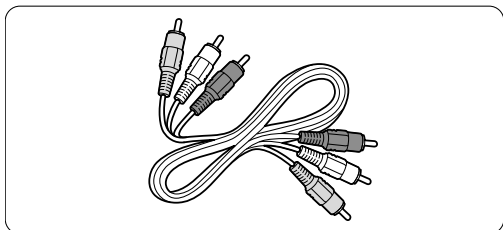

Combined Video - yellow and Audio L/R cable - red and white

---

### 7.2.2 HDMI with EasyLink

Connected devices that are compliant with the HDMI CEC standard can work together:

- 1 Press **Menu**  > Setup > Installation > Preferences and press **▶** to enter the list.
- 2 Press **▲** or **▼** to select **EasyLink**.
- 3 Press **▶** to enter.
- 4 Press **▲** or **▼** to select **On** or **Off**.
- 5 Select **On** to activate EasyLink.

EasyLink might not work with devices from other brands.

#### One touch play

Insert a DVD disc and press Play. The TV switches on from standby and shows the DVD programme automatically.

#### System standby

Press the  key on the remote control for more than 2 seconds to switch the connected devices in standby.

#### System audio control

When you connect an audio system you can listen to the sound from your TV through your audio system while the TV speakers are muted. See section **5.4.5 Sound settings, TV speakers**.

#### Note

Ensure that all HDMI-CEC features in the HDMI-CEC devices (for ex. Home Theatre System) are properly set up.

---

### 7.2.3 Display synchronised audio out

For the best match of image and sound in speech on screen, connect a Home Theatre System to Audio Out L/R or Digital Audio outputs. See diagrams **7.4.4** and **7.4.8**.

Do not connect the audio signal of a DVD player, digital receiver or other audio/video device directly to the Home Theatre System.

---

### 7.3 Connect with the Connection assistant

(if available)

Use the Connection assistant to show you how to connect your devices to your TV. It sets all necessary settings automatically.

You can also connect your devices without the use of the Connection assistant. See section **7.4 Connect without the Connection assistant**.

**Connect without the Connection assistant.**

- 1 Press **Menu**  on the remote control and select Setup > Installation > **Connection assistant**.
- 2 Press **▶** to start the Connection assistant.
- 3 Press **OK**.

---

### 7.4 Connect without the Connection assistant

The connections shown in this section are recommendations for the most used cases. Other solutions are possible.

When a device is connected the TV needs to know what connection you made. See section **7.5 Connection setup**.

**Connection setup.**

### 7.4.1 DVD player

Use a scart cable to connect the device to the EXT1 input at the back of the TV.

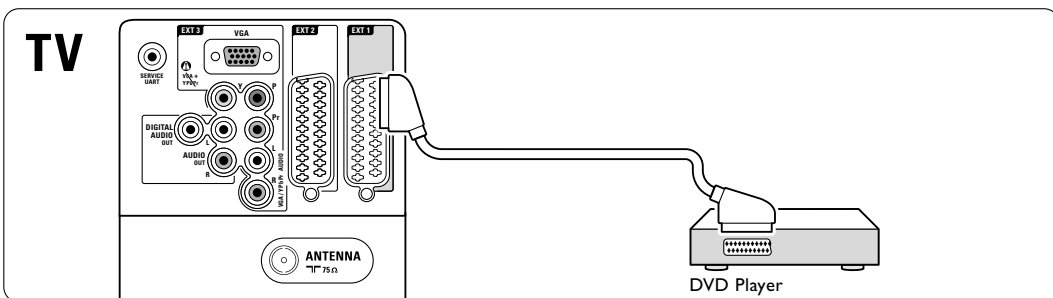

### 7.4.2 DVD Recorder or Digital Receiver

Use a scart cable and 2 antenna cables.

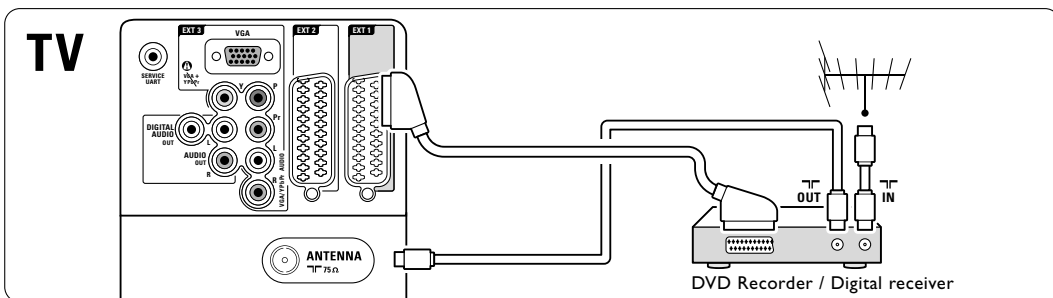

### 7.4.3 DVD Recorder and Digital Receiver

Use 3 scart cables and 3 antenna cables.

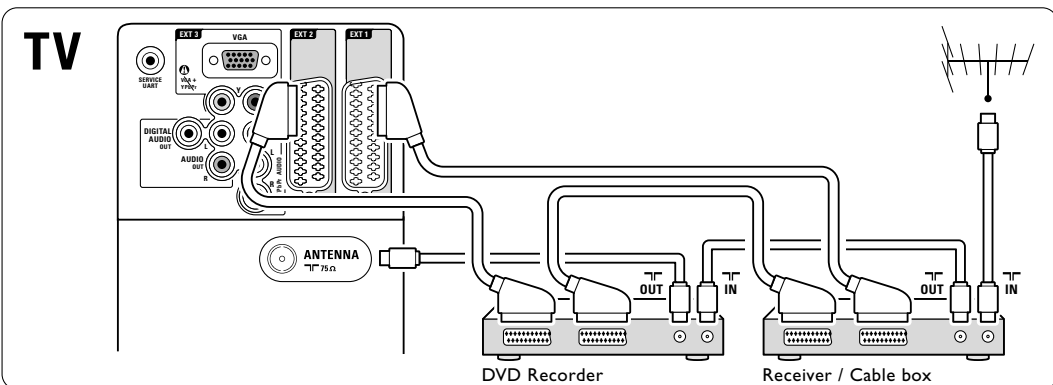

### 7.4.4 DVD Recorder and Home Theatre System

Use a scart cable, 2 antenna cables and 1 digital audio (cinch) cable.

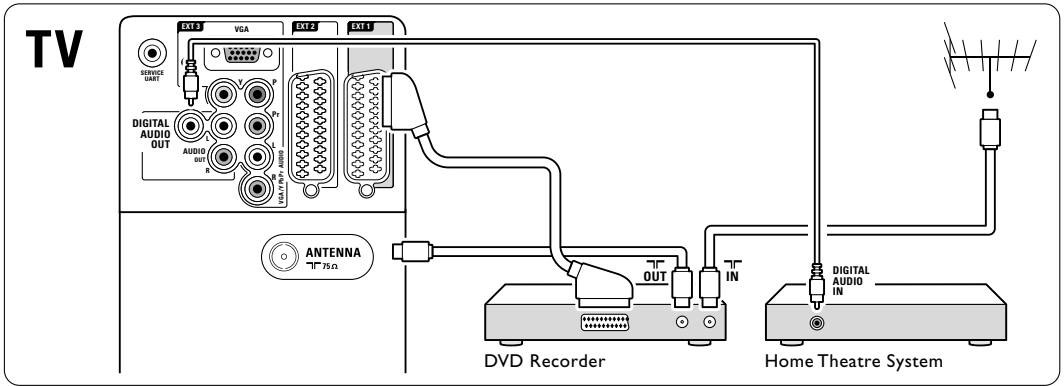

### 7.4.5 DVD Recorder and DVD Home Theatre System

Use 2 scart cables, 2 antenna cables and 1 digital audio (cinch) cable.

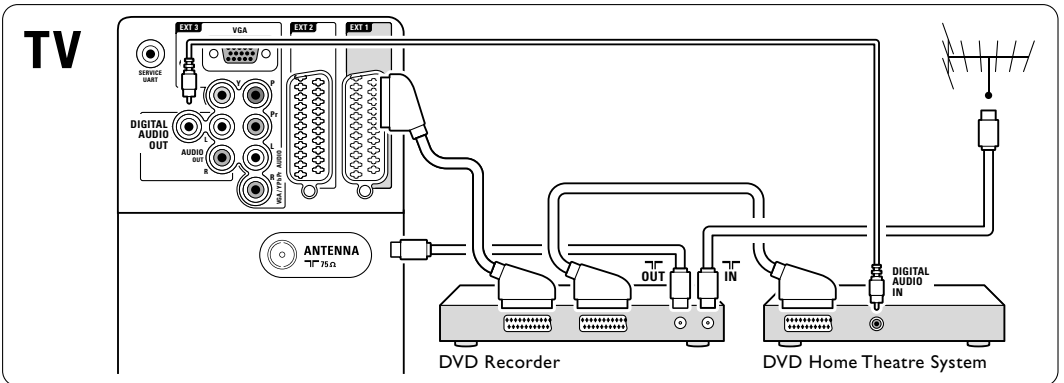

### 7.4.6 Satellite receiver

Use a scart cable and 2 antenna cables.

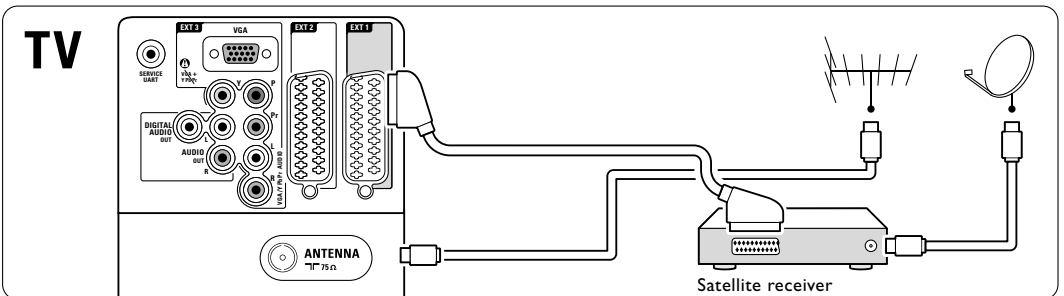



### 7.4.7 HD Digital receiver / HD satellite receiver

Use an HDMI cable and 2 antenna cables.

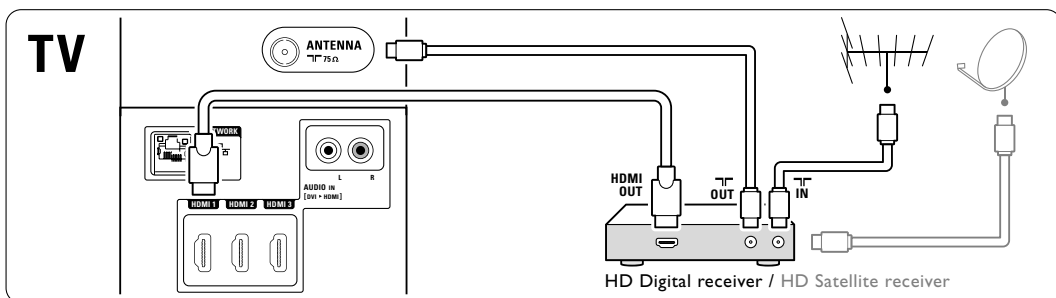

### 7.4.8 DVD-R, Home Theatre System and Digital receiver

Use 3 scart cables, 3 antenna cables and 1 audio (cinch) cable.

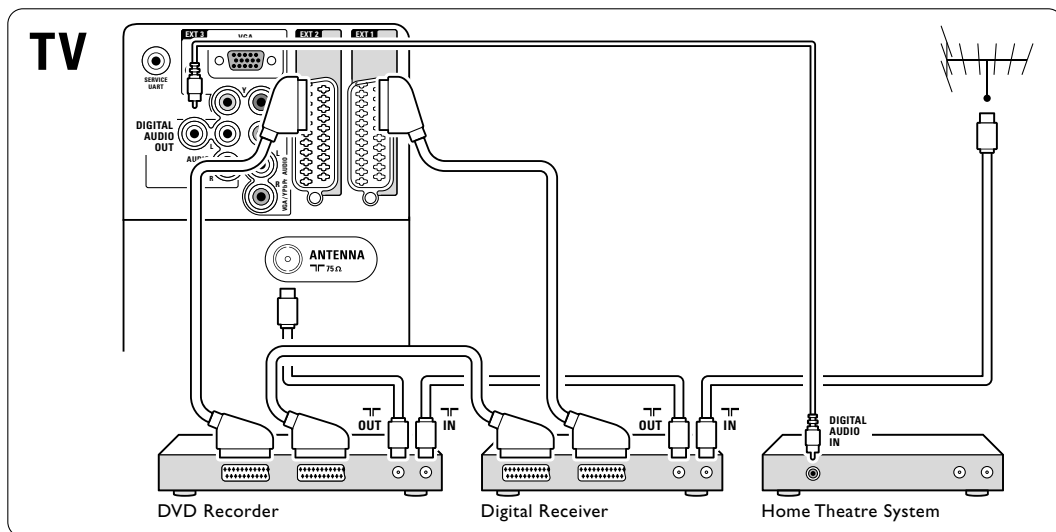

### 7.4.9 Blu-ray Disc player

Use an HDMI cable.

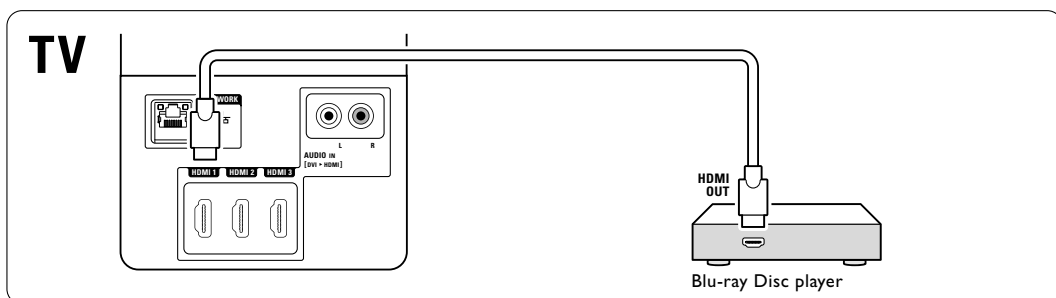

### 7.4.10 Game console

The most practical connections for a game console are at the side of the TV.

#### Connected at the side of the TV

Use the HDMI connection or the S-Video and Audio L/R connections or the Video and Audio L/R connections.

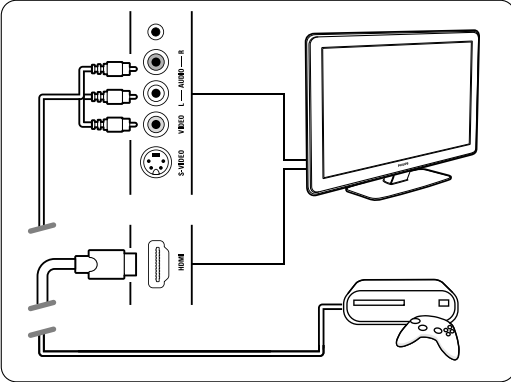

#### Connected at the back of the TV

Use an HDMI connection or the EXT3-YPbPr and Audio L/R connections for HD quality

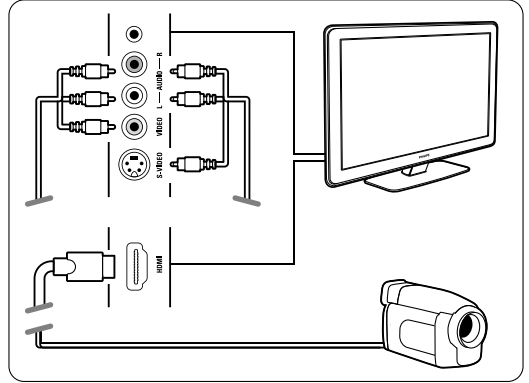
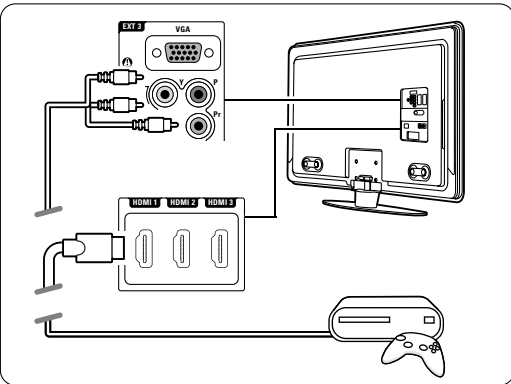

#### Connected at the back of the TV

Use an HDMI connection or the EXT3-YPbPr and Audio L/R connections for HD quality.

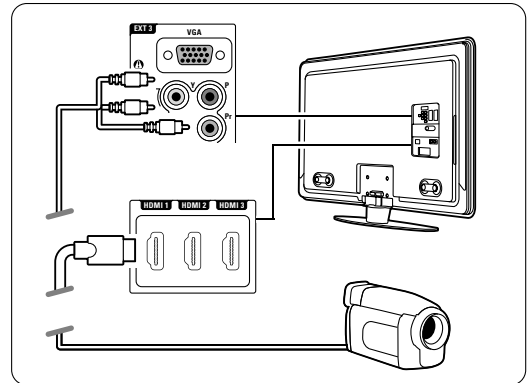

### 7.4.11 Camcorder

The most practical connection for a camcorder is at the side of the TV.

#### Connected at the side of the TV

Use the HDMI connection or the Video and Audio L/R connections or use the S-Video and Audio L/R connections.

### 7.4.12 Personal Computer

You can connect your PC directly to the TV. The TV works as a monitor of your PC.

For more features you can connect your PC in a PC network. See section **7.7 PC network**.

As a monitor the PC can be connected at the side with a DVI to HDMI adaptor or with a PC to TV cable. Alternatively you can connect the PC at the back with the VGA connection.

#### ⚠ Caution

Before connecting the PC, set the PC monitor refresh rate to 60Hz.

#### 💡 Tip

Set the TV picture format to Unscaled in the Picture format menu for maximal PC picture sharpness. See section **5.4.4 Widescreen picture format**.

#### DVI to HDMI connection

Use a DVI to HDMI adaptor to connect to the HDMI side connection.

Connect the Audio L/R at the side for sound.

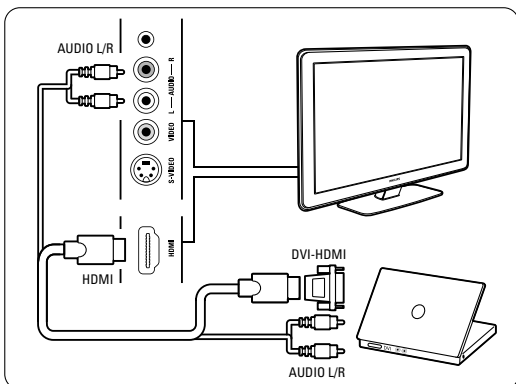

#### PC to TV connection

Use a PC-TV out cable to S-Video and Audio L/R cable to connect to the side of the TV.

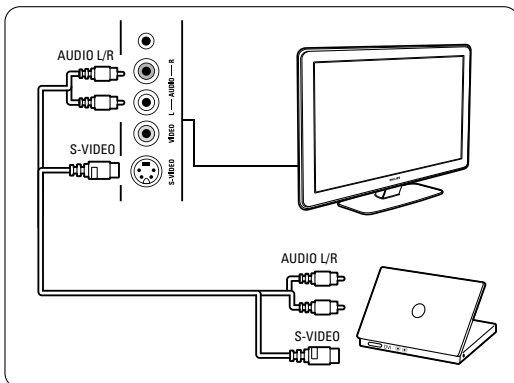

#### VGA connection

Use a VGA cable to connect the PC to the EXT3 connection at the back of the TV.

Connect the Audio L/R to the EXT3 Audio L/R.

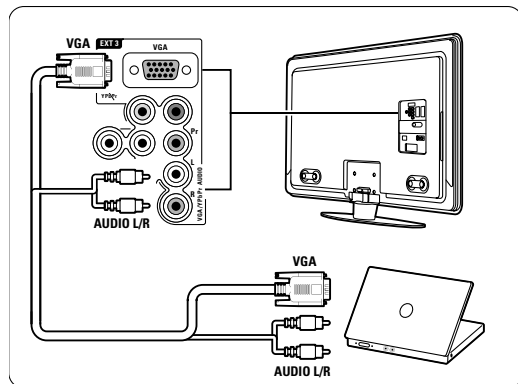

For supported PC monitor resolutions, see section **8 Technical data**.

## 7.5 Connection setup



The TV needs to know what connections you have made and which device is connected to which connector.

If you have used the Connection assistant the connection setup is already done.

### 7.5.1 Naming your devices

Name the connected devices for easy selection and best signal handling.

Assign the type of device (DVD, VCR, Game, ...) to the connector you use for that device.

- 1 Press **Menu**  on the remote control and select Setup > Installation > **Rename devices**.
- 2 Press **▶** to enter the list.
- 3 Press **▲** or **▼** to select the connector you used for the device you connected.
- 4 Press **▶**.
- 5 Press **▲** or **▼** to select the type of device.
- 6 Press **Menu**  to quit the menu.

### 7.5.2 Audio setup (if present)

If you use the Audio In L/R (DVI to HDMI) connector for a device connected to HDMI at the back of the TV, assign this Audio In to the HDMI 1, 2 or 3 where the device is connected.



- 1 Press **Menu**  on the remote control and select Setup > Installation > **Audio setup**.
- 2 Press **▶** twice.
- 3 Press **▲** or **▼** to select the HDMI connection to link with this Audio In.

Audio setup	Audio in L/R
<b>Audio in L/R</b>	None
	HDMI 1
	HDMI 2
	HDMI 3

### 7.5.3 Decoder channels

Decoders that decode an antenna channel are connected to **EXT1** or **EXT2** (scart).

You have to assign the TV channel as a channel to be decoded. Then assign the connection where the decoder is connected

- 1 Press **Menu**  on the remote control and select Setup > Installation > Decoder > **Channel**.
- 2 Press **▶** to enter the list.
- 3 Press **▲** or **▼** to select the channel to decode.
- 4 Press **◀** and go back to select **Status**.
- 5 Press **▲** or **▼** to select the connector used by the decoder.
- 6 Press **Menu**  to quit the menu.

Installation	Decoder
...	Channel
Connections assist.	Status
Rename devices	
Audio setup	
<b>Decoder</b>	
Man. network inst.	
Clock	
Factory settings	

## 7.6 Preparing for digital services

Scrambled digital TV channels can be decoded with a Conditional Access Module (CAM) and a Smart card provided by a digital TV service operator. The CAM may enable several services depending on the operator you choose (e.g. Pay TV).

Contact your digital TV service operator for more information and terms.

### 7.6.1 Insert a Conditional Access Module - CAM

#### Warning

Switch off the TV before inserting the CAM.

Look on the CAM for the correct inserting direction. Incorrect insertion can damage the CAM and the TV.

- 1** Gently insert the CAM into the **Common Interface** slot at the side of your TV as far as it will go.
- 2** Leave the CAM in the Common Interface slot permanently.

It can take a few minutes before a CAM is activated. Removing the CAM will deactivate the digital TV service.

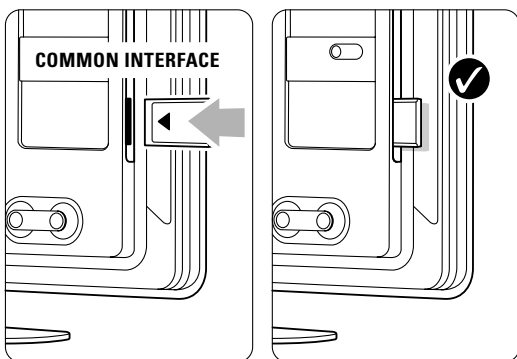

### 7.6.2 Common interface menu

From this menu you access the CAM service you have installed. The applications and their function, the content and the messages on screen come from the CAM service provider.

- 1** Press **Menu**  on the remote control and select **Features > Common interface**.

This menu option is available when a CAM is inserted and has made contact with the provider.

## 7.7 PC network

You can link up your TV on a PC network in your home. Watch your photos and listen to your music from any linked PC on the TV. The PC network feature of this TV is DLNA certified.

You can use Microsoft Windows XP or Vista, Intel Mac OSX or Linux.

An example of a home PC network.

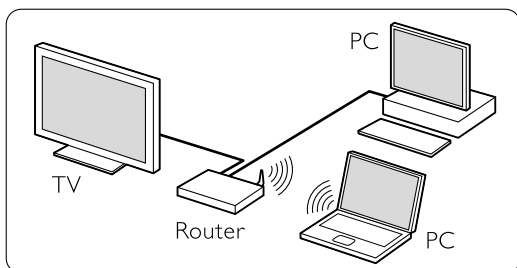

### 7.7.1 What you need

To set up your TV in a home PC network you need:

- a router and a computer in a home network
- a network cable
- recent media server software (Windows, media Player 11 or similar) on your computer.

For a complete list of compatible media server software see section 8 Technical data.

### 7.7.2 Set up a PC network connection

On the TV no special settings are necessary to connect automatically to the network.

- 1 Connect the network cable from your router to the **Network**  connector at the back of the TV.

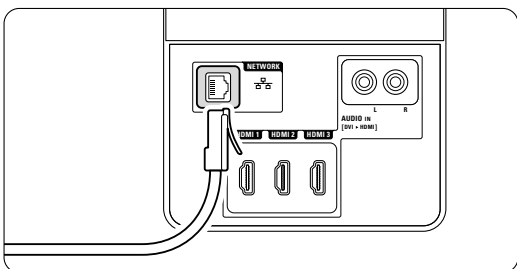

- 2 Switch on the router. Set the router to DHCP On.
- 3 Switch on the computer and start the media server software.

- 4 Some media server software needs a setting to share your files with the TV.

In the media server this TV will present itself as a number - a MAC or IP number.

Have the TV and router switched on for this number to appear in the media server.

Select the TV number in the media server and set the server to share files with this number. For media server software marked with an \* in sections 8 Technical data, a step by step setting instruction is available. See section 7.7.4 Media server settings.

A firewall, a security system on your computer, could also block the network connection.

Allow the media server software to go to the network.

- 5 Press the **Source**  key on the remote control.
- 6 Select **PC network** and press **▶**.
- 7 Use the colour and navigation/rotation keys to browse your folders or play your files.

If the TV cannot connect to the network, study the server software, router or PC manuals.

### 7.7.3 Manual network setup

Some expert network settings can be set on the TV. The DHCP is set to On to automatically connect to the network.

Press **Menu**  > Setup > Installation > Manual network installation.

## 7.7.4 Media server settings

Media servers need to be set for sharing their files and folders. Follow the instructions closely to set your specific server.

### Windows Media Player v11 on Windows Vista

#### Set for network sharing

In **Windows Media Player** select **Library** from the menu and select **Media sharing**.



In the **Media Sharing** window, check the **Share my media** box. Click **OK**.

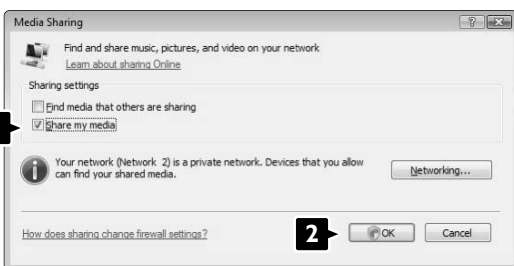

If no network connection was found, and you are unable to check this box, click the **Networking** button to show the **Network and Sharing Center** window, ...

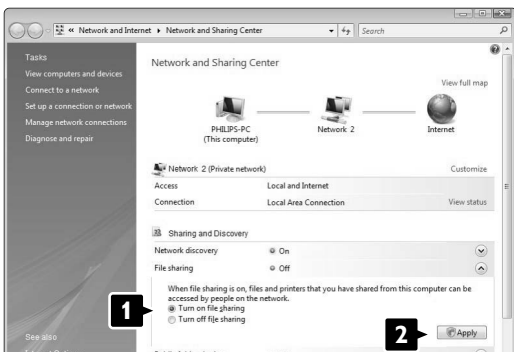

Set **Network discovery** to **On**. Set **File sharing** to **On**. Go back to the **Media Sharing** window in **Windows Media Player** and check the **Share my media** box. Click **OK**.

When the TV is connected, by the router, to the PC and everything is switched On, the **Media sharing** window will show the TV as an **Unknown Device**. Select the device and click **Allow**.

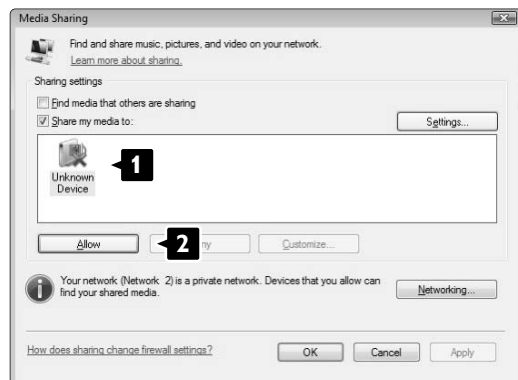

You can open the **Settings** window to change particular settings on sharing. When the device icon (the TV) is checked with a green tick, click **OK**.

#### Set folders for sharing

In **Windows Media Player** select **Library** from the menu and select **Add to Library**.



In the **Add To Library** window, select **My folders and those of others that I can access** and click the **Advanced Options** button. ...



With **Advanced Options** open, you can add specific folders to the list to share. Click **Add**.

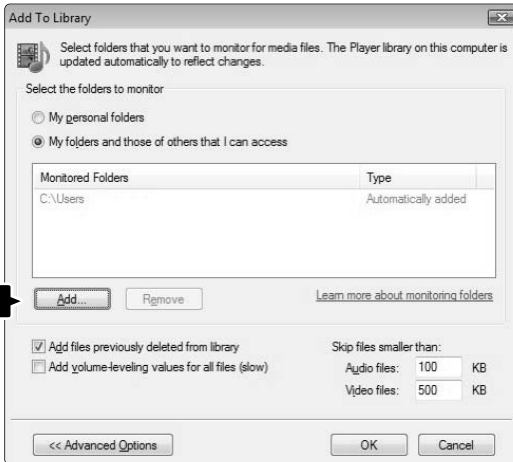

In the **Add Folder** window select a folder with music, photos or videos you want to share with other devices (your TV). Click **OK**.



In the **Add To Library** window the newly added folder is shown. You can add more folders to share. Click the **OK** button to add the files to the library.

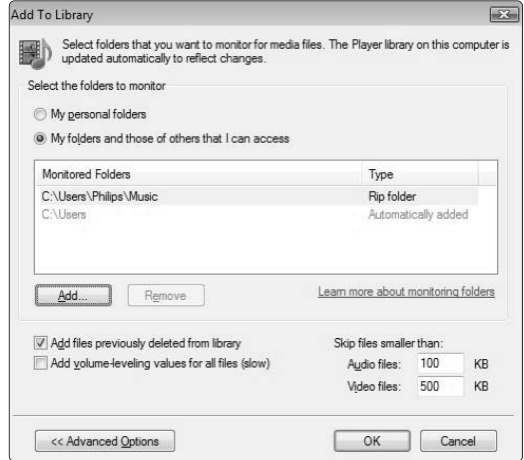

Now everything is set to enjoy music, photos and videos on your TV.

## Windows Media Player v11 on Windows XP

### Set for network sharing

In Windows Media Player select **Library** from the menu and select **Media sharing ...**





In the **Media Sharing** window, check the **Share my media** box.

When the TV is connected, by the router; to the PC and everything is switched On, the **Media sharing** window will show the TV as an **Unknown Device**. Select the device and click **Allow**.

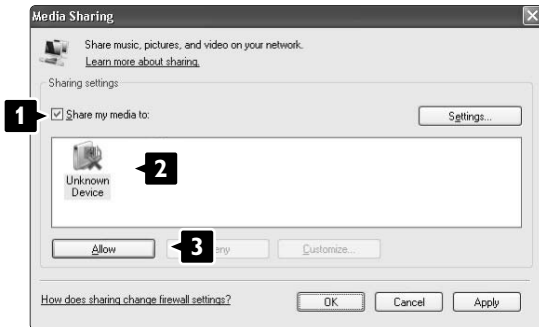

You can open the **Settings** window to change particular settings on sharing. When the device icon (the TV) is checked with a green tick, click **OK**.

### Set folders for sharing

In Windows Media Player select **Library** from the menu and select **Add to Library**.



In the **Add To Library** window, select **My folders and those of others that I can access** and click the **Advanced Options** button.

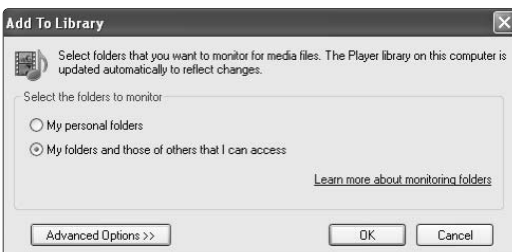

With **Advanced Options** open, you can add specific folders to the list to share. Click **Add**.

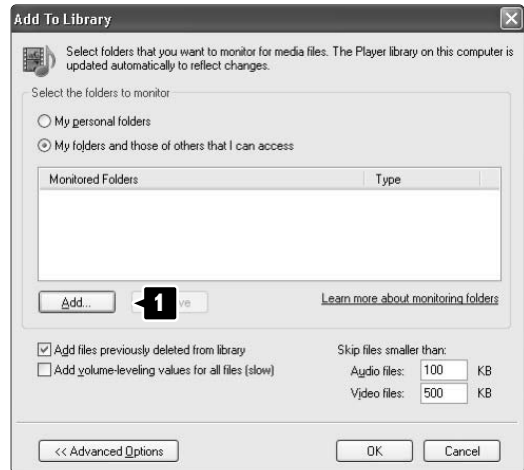

In the **Add Folder** window select a folder with music, photos or videos you want to share with other devices (your TV). Click **OK**.



In the **Add To Library** window the newly added folder is shown. You can add more folders to share. Click the **OK** button to add the files to the library.

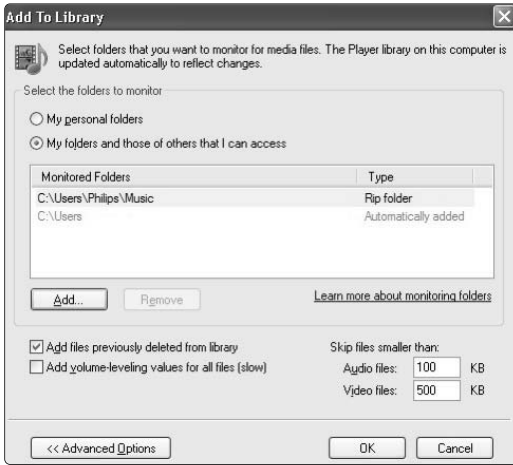

Click the **Sharing** tab.



### Set folders for sharing

Click the green plus icon and select **Add folder...**

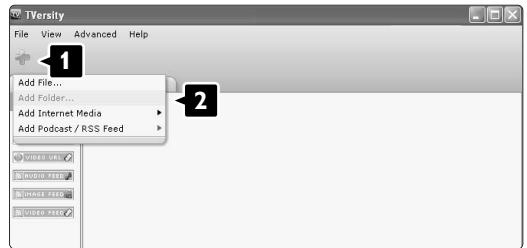

Now everything is set to enjoy music, photos and videos on your TV.

## Tversity v.0.9.10.3 on Windows XP

### Set for network sharing

Click the **Settings** tab and click the **Start Sharing** button.

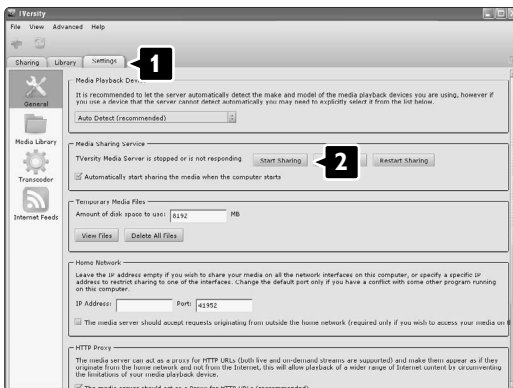

A pop-up window tells you that the media server service is started. Click **OK**.

In the **Add media** pop-up window, click the **Browse** button.

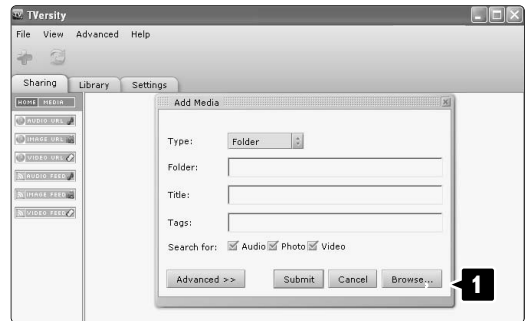

In the **Browse for Folder** window select a folder with music, photos or videos you want to share. Click **OK**.

Now everything is set to enjoy music, photos and videos on your TV.

# Twonky Media v4.4.2 on Macintosh OS X

## Set for network sharing

In **Twonky Media** click **Basic Setup > First steps**. In this window you can change the server name that appears on your TV.

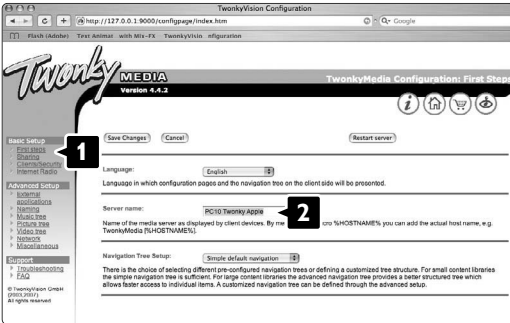

Click **Basic Setup > Clients/Security**. Check the box next to **Enable sharing for new clients automatically**.

## Set folders for sharing

Click on **Basic Setup > Sharing**. Some 'Content Locations' might be set already automatically. To add a folder (a content location) to be shared on the network click the **Browse** button.



In the blue frame click the hard disk name to browse to a folder with music, photos or videos you want to share with other devices (your TV).

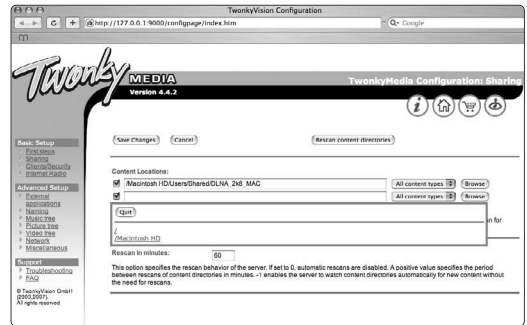

Click **Select** to select the folder for sharing. Now click **Save Changes**.

Then click **Rescan content directories**. In some cases this might not make all files and folders available.

Click **Support > Troubleshooting** and click **Rebuild database** to make sure everything works OK. This rebuilt might take a while.

Now everything is set to enjoy music, photos and videos on your TV.

## 8 Technical data

### Picture / Display

- Display type: LCD Full HD W-UXGA
- Panel resolution: 1920x1080p
- Perfect Pixel HD picture enhancement
- 1080p 24/25/30/50/60Hz processing
- 100 Hz Clear LCD (if present)

### Supported display resolutions

- Computer formats

Resolution	Refresh rate
640 × 480p	60Hz (VGA/HDMI)
600 × 800p	60Hz (VGA/HDMI)
1024 × 768p	60Hz (VGA/HDMI)
1280 × 768p	60Hz (VGA/HDMI)
1360 × 765p	60Hz (VGA/HDMI)
1360 × 768p	60Hz (VGA/HDMI)
1280 × 1024p	60Hz (HDMI)
1920 × 1080i	60Hz (HDMI)
1920 × 1080p	60Hz (HDMI)

- Video formats

Resolution	Refresh rate
480i	60Hz
480p	60Hz
576i	50Hz
576p	50Hz
720p	50Hz, 60Hz
1080i	50Hz, 60Hz
1080p	24Hz, 25Hz, 30Hz
1080p	50Hz, 60Hz

### Tuner / Reception / Transmission

- Antenna input: 75ohm coaxial (IEC75)
- TV system: DVD COFDM 2K/8K, (MPEG2, MPEG4 if available)
- Video playback: NTSC, SECAM, PAL
- DVD: DVB Terrestrial (see selected countries on the TV typeplate)

### Sound

- Sound system:
  - Virtual Dolby Digital
  - BBE

### Multimedia

- Connections: USB
- Playback formats: MP3, Slideshow (.alb) JPEG, MPEG1, MPEG2.

Supported media server software

- Windows Media Player 11 (on Microsoft Windows XP\* or Vista\*)
- PacketVideo Twonky Media 4.4.2 (on PC\* & Intel Mac OSX\*)
- Sony Vaio media server (on Microsoft Windows XP or Vista)
- TVersity v.0.9.10.3 (on Windows XP\*)
- Nero 8 - Nero MediaHome (on Microsoft Windows XP)
- DiXiM (on Windows XP)
- Macrovision Network Media Server (on Windows XP)
- Fuppes (on Linux)
- UShare (on Linux)
- Philips Media Manager (on Microsoft Windows XP)
- Philips NAS SPD8020

\* For this media server software a step by step setting instruction is available in the online User manual on [www.philips.com/support](http://www.philips.com/support).

Supported USB/Memory device formats

- FAT 16, FAT 32, NTFS.

### Remote control

- Type: RC4492  
RC4494 (42PFL9803)
- Batteries: 3 Size AAA-LR03-1,5V type

### Connectivity

Back

- EXT1 (scart): Audio L/R, CVBS in, RGB
- EXT2 (scart): Audio L/R, CVBS in, RGB,
- EXT3: Y Pb Pr or VGA, Audio L/R
- HDMI 1 in (HDMI 1.3a for all HDMI connections)
- HDMI 2 in
- HDMI 3 in
- Audio In L/R (DVI to HDMI)
- Audio Out L/R - display synchronised
- Digital Audio out (coaxial-cinch-S/PDIF) - display synchronised
- Network - (RJ45)

Side

- HDMI side in
- S-Video in (Y/C)
- Video in (CVBS)
- Audio L/R in
- Headphone (stereo mini jack)
- USB
- Common interface slot

**Power**

- Mains power: AC 220-240V ( $\pm 10\%$ )
- Power and standby power consumption:  
See technical specification on [www.philips.com](http://www.philips.com)
- Ambient temperature: 5°C - 35°C

Specifications are subject to change without notice.  
For more specification details of this product see  
[www.philips.com/support](http://www.philips.com/support).

**Dimensions and weights (approx.)**

TV model	32PFL9603D/H 32PFL9613D/H	37PFL9603D/H	42PFL9603D/H 42PFL9703D/H 42PFL9803H	47PFL9603D/H 47PFL9703D/H	52PFL9703D/H
- width	828mm	953mm	1054mm	1167mm	1300mm
- height	534mm	604mm	658mm	722mm	803mm
- depth	109mm	101mm	100mm	101mm	127,5mm
- weight	$\pm 19\text{kg}$	$\pm 25\text{kg}$	$\pm 28\text{kg}$	$\pm 35,5\text{kg}$	$\pm 45,5\text{kg}$
<b>TV + stand</b>					
- width	828mm	953mm	1054mm	1167mm	1300mm
- height	594mm	677mm	731mm	795mm	875mm
- depth	220mm	242mm	265mm	290mm	320mm
- weight	$\pm 20\text{kg}$	$\pm 28,5\text{kg}$	$\pm 32,5\text{kg}$	$\pm 40,5\text{kg}$	$\pm 49\text{kg}$

---

## 9 Troubleshooting

---

### Television and remote control

#### The TV does not switch on

- Verify the mains cord connection.
- Verify if the batteries of the remote control are not empty or weak. Verify their + / - orientation. You can use the keys on the TV to switch the TV on.
- Unplug the mains cord, wait a minute and plug it back in. Try again to switch on.

#### The TV does not react on the remote control

- Verify if the batteries of the remote control are not empty or weak. Verify their + / - orientation.
- Clean the remote control and TV sensor lens.

#### The TV switches off and the red light blinks



- Unplug the mains cord, wait a minute and plug it back in. Verify if there is enough space for ventilation. Wait until the TV has cooled down. When the TV does not restart to standby and the blinking occurs again, call our Customer Care.

#### You forgot your code to unlock Child lock

- See section 5.9.3 Set code / Change code.

#### Wrong language in the TV menu ?

Follow these steps to change the language.

- 1** Press **Menu**  on the remote control.
- 2** Use **▼** to select the last menu line.
- 3** Press **▶** three times.
- 4** Press **▲** or **▼** to select your language.
- 5** Press **OK**.
- 6** Press **Menu**  to quit the menus.

---

### TV channels

#### Some TV channels are gone

- Verify if the correct channel list is chosen.
- A channel could be uninstalled in the **Rearrange menu**.

#### No digital channels found during installation

- Verify if the TV supports DVB-T or DVB-C in your country. See the label "Digital TV Country Compatibility" on the back of the TV.

---

### Picture

#### LightGuide is on but there is no picture

- Verify if the antenna is connected properly.
- Verify if the correct device is selected.

#### The sound is on, but there is no picture

- Verify the contrast or brightness setting in the menu.

#### The TV picture is poor

- Verify if the antenna is connected properly.
- Non-earthed audio devices, neon lights, high buildings or mountains can influence the picture quality. Try to improve the picture by changing the antenna direction or place devices away from the TV.
- Verify if the correct TV system is chosen in the Manual installation menu.
- If only a certain channel is poor, try to fine tune this channel in the **Fine tune** menu. See section 6.2.3.

#### The picture has poor colour

- Verify the colour settings in the Picture menu. Select any of the Reset to standard settings in the **Smart settings** menu. See section 5.4.1.
- Verify the connections and cables of the connected devices.

#### The TV does not remember my settings when I switch back on

- Verify if the TV is set to **Home** in the TV menu > Setup > Installation > Preferences > **Location** menu.

#### The picture does not fit the screen, it is too big or too small

- Select a more fitting picture format in the Picture format menu. See section 5.4.4 **Widescreen picture format**.
- Name your connected device in the Connections menu to obtain the best signal handling. See section 7.4.1 **Naming your devices**.

#### The picture position on screen is not correct

- Some picture signals from some devices do not fit the screen correctly. You can shift the picture with the navigation key on the remote control. Verify the signal output of the device.

---

### Sound

#### There is a picture but no sound

- Verify the volume is not set to 0.

- Verify the sound has not been muted with the  key.
- Verify if all cables are connected properly.
- If no sound signal is detected, the TV automatically switches off the sound.  
This is proper operation and is not a malfunction.

#### The sound is poor

- Verify if the sound is set to Stereo.
- Verify the Equalizer in the Sound menu.
- Select any of the Smart settings in the menu.

#### The sound comes from one speaker only

- Verify if the Balance is not set to extreme left or right.

#### Sound delay when A HTS-DVD device is connected

- See the user manual of the HTS-DVD device to adjust the audio sync delay.  
If you cannot set A delay, switch off HD Natural Motion in the Picture > Perfect Pixel HD menu.  
See section **5.4.3 Picture settings**.

## HDMI connections

#### Trouble with devices connected with HDMI

- The HDMI - HDCP procedure might take a few seconds before the TV shows the picture from a device.
- If the TV does not recognise the device and the screen shows no picture, try switching from one device to another and back again to restart the HDCP procedure.
- If sound interruptions occur persistently, see the user manual of the device to verify the output settings. If that does not help, connect an additional audio cable.
- If a DVI to HDMI adaptor is used, verify if an additional audio connection is in place to complete the DVI connection.
- HDMI with EasyLink does not work
  - Verify if the connected device supports the HDMI CEC standard. See the user manual that comes with the device.
  - Verify if the HDMI cable is properly connected.
  - Verify if Easylink is activated in the Setup, Installation, Preferences menu.
  - Ensure that the System audio control in your HDMI CEC audio devices is properly set up. See the user manual that comes with your audio device.

## USB connection

#### The TV does not show the USB device content

- Set your device (camera) to 'Mass Storage Class' compliant.
- The USB device may need specific driver software. Unfortunately this software cannot be downloaded to your TV.

#### I cannot see my files in the Multimedia menu.

- Not all audio and picture files are supported. See section **8 Technical data**.

#### Photo and music files do not playback smoothly

- The transfer performance of the USB device limits the transfer rate.

## Personal computer

#### The PC display on my TV is not stable or is not synchronised

- Verify if the correct resolution mode is selected on your PC. See section **8 Technical data**.

#### I cannot find my PC files on my PC

- Verify if files have been added in the folder.
- Not all file formats are supported. See section **8 Technical data**.

#### PC files are not shown in the PC network menu

- You have to set the PC media server to share files with the TV. See section 7.7.2 Set up a PC network connection.

#### PC files do not play

- See section 8 Technical data for supported file formats.

#### If your problem is not solved

Switch your TV off and on again, that may help. If not, call our Consumer Care or consult our website [www.philips.com/support](http://www.philips.com/support).

Find the Consumer Care telephone numbers on the back cover of this manual.

#### Please, have the TV Model and Product Number ready before you call.

You can find these numbers on the packaging label or on the typelabel on the back and bottom of the TV.

#### **Warning**

Never try to repair the TV yourself.

---

# 10 Index

100 Hz Clear LCD 5,17

## A

Active control 17  
Advanced sharpness 17  
Ambilight  
  active mode 19  
  LoungeLight 11  
  menu / settings 19  
  modes 19  
Analogue  
  manual installation 31  
  TV channels 31  
Antenna  
  cable 7  
  connect 7  
  with devices 34  
Audio setup 42  
Auto clock mode 31  
Auto format 18  
Automatic installation 30  
Auto surround 19  
Auto Volume levelling 19

## B

Balance  
  sound 19  
Batteries 3,7  
Blacklevel 17  
Blu-ray Disc 39  
Brightness 17  
  ambilight 19

## C

CA module 43  
Cable  
  HDMI 35  
  Scart 35  
  S-Video 35  
  Video 36  
  YPbPr 35  
Camcorder 40  
Camera (photo) 40  
Care of the screen 3  
Change code 24  
Channel  
  all channels list 21  
  favourite list 21  
  installation 30  
  lock 24

Channel  
  management 32  
  up/down 13  
  previous 13  
  rearrange 32  
  store / install 31  
Child lock 24  
Clock 13,31  
Code 24  
Colour  
  enhancement 17  
  menu 17  
  keys 4,12  
Common interface (CAM)  
  menu 43  
  slot 34,43  
Connection  
  best 35  
  overview 34  
  set up 42  
Contrast 17  
Country selection 30  
Custom lock 24  
Custom tint 17

## D

Daylight saving 31  
Decoder channel 42  
Delta volume 19  
Device  
  connecting 36  
  naming 42  
  watch 9  
DHCP 44  
Digital  
  audio out 34  
  subtitle language 25  
  receiver 37  
  text services 21  
  test reception 33  
Dual I/II 19  
Dual screen 13  
DVB-T 5  
DVD  
  connect 37  
  playback 10  
  player 37  
  recorder 37,38

Dynamic  
  backlight 17  
  contrast 17

## E

EasyLink 36  
Electronic Programme Guide 22  
Energy saving 16  
Equalizer 18  
External 1,2,3 (EXT) 34

## F

Factory settings 33  
Favourite channel lists 21  
Fine tune 32

## G

Game console 40

## H

HDCP 35  
HDMI connection 35  
HD digital receiver 39  
HD natural motion 17  
Headphone  
  connect 4,34  
  volume 19  
Hearing impaired 30  
Home theatre system 38  
Hue 17

## I

Installation  
  automatic 30  
  manual 31  
  manual network setup 44  
  menu 30  
  update 32

## K

Kensington Security Slot 5  
Key(s)  
  colour 12  
  on TV 4  
  on remote control 4,12

## L

Language  
  menu 30  
  audio 19



Language  
 subtitle 25  
 LightGuide 15  
 Light sensor 17  
 Location 47  
 Locks 24  
 LoungeLight 11

**M**

Menu key 13  
 Mono 19  
 Movie expand 18  
 MPEG artefact reduction 17  
 Music 25  
 Mute key 12

**N**

Naming devices 42  
 Network setup 44  
 Noise reduction 17

**O**

OK key 12  
 On timer 24

**P**

Perfect Pixel HD 17  
 Personal Computer  
 connect 41  
 display resolutions 50  
 Photo viewer 26  
 Picture  
 album 26  
 format 18  
 menu 17  
 Position the TV 5  
 Power cable 7  
 Preferred audio format 30

**R**

Radio channel 27  
 Rearrange channels 32  
 Recorder 37  
 Recycling 3  
 Remote control  
 assistant 13  
 batteries 7  
 mode 13  
 overview 12  
 setup code 16  
 Remote control  
 universal 13  
 Rename 32  
 Reorder 32

**S**

Safety 3  
 Satellite receiver 38  
 Scart connection 35  
 Screen cleaning 3  
 Search  
 channels 31  
 teletext pages 20  
 Set code 24  
 Settings assistant 16  
 Sharpness 17  
 Sleptimer 24  
 Smart settings 16  
 Software update 28  
 Sound  
 menu 18  
 surround mode 19  
 Standby 12,24  
 Super zoom 18  
 Stationary images 3  
 Stereo 19  
 Subtitle 25  
 language 25  
 shift 18  
 Switch on 8

**T**

Table of Pages T.O.P 20  
 Technical data 50  
 Teletext 20  
 digital 21  
 dual screen 20  
 language 20  
 menu 21  
 page 20  
 teletext 2.5 21  
 Time zone 31  
 Timers 24  
 Tint 17  
 Troubleshooting 52  
 TV speakers 19

**U**

Universal mode 13  
 Universal remote control 13  
 Unmount the stand 6  
 Unscaled 18  
 USB  
 connector 34  
 device 25  
 photo viewer 25

**V**

VCR  
 connect 37  
 VGA 41  
 Video cable 36  
 Video formats 50  
 Visual impaired 30  
 Volume  
 bar 18  
 key 12  
 visual impaired 19

**W**

Whitepoint 17  
 Widescreen picture format 18

**Y**

YPbPr 35

# Information about how to re-tune your TV during the digital TV switchover.

Keep this user manual safe  
- you'll need it.

.....

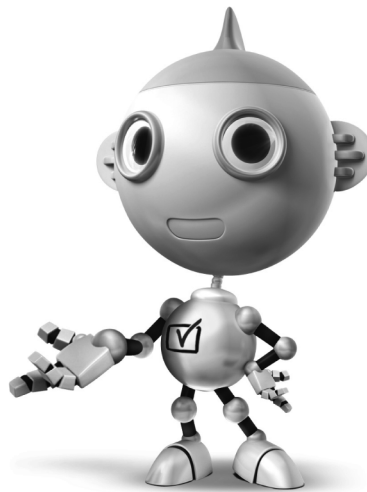

Television in the UK is going digital, bringing us all more choice and new services. Starting in late 2007 and ending in 2012, television services in the UK will go completely digital, TV region by TV region.

Please see the next page to find out when your area switches to digital.

Digital UK is the independent, non-profit organisation leading the process of digital TV switchover in the UK. Digital UK provides impartial information on what people need to do to prepare for the move to digital, and when they need to do it.

## How the switch over affects your TV equipment:

Your new TV has a digital tuner built in, which means it is ready to receive the Freeview signal by simply plugging it into your aerial socket (check if you can get digital TV through your aerial now, or whether you'll have to wait until switchover; at [www.digitaluk.co.uk](http://www.digitaluk.co.uk)).

When the TV switchover happens in your area, there are at least two occasions when you will need to re-tuner your TV in order to continue receiving your existing TV channels, and also to pick up new ones.

get set for digital 

Digital UK, the body leading the digital TV switchover, will advise you when you need to re-tuner during the switchover.

If you choose to connect your TV to satellite or cable with a digital box then it will not be affected by switchover, and you won't need to re-tune.

If you have any questions, please contact your equipment supplier or call Digital UK on ... 0845 6 50 50 50 or visit [www.digitaluk.co.uk](http://www.digitaluk.co.uk)

## How to re-tune:

To find out how to re-tune your TV, check this user manual for details.

Go to section 6.1 Automatic installation and go to Step 4 Install TV and radio channels.

If you do not re-tune your channels when advised to do so by Digital UK, you may lose some or all of your channels until you do re-tune. You should re-tune your TV every few months to check for any new channels.

If you are missing any channels, it may be that they are not available in your area, or that your aerial needs upgrading.

## When does switchover happen?

\* Copeland switches on October 17, 2007

The exact date you switch depends on the transmitter you are served by. To check when you switch, go to Digital UK's postcode checker on [www.digitaluk.co.uk](http://www.digitaluk.co.uk). Check your ITV news service or look at Teletext page 106 to see what TV region you're in.

Visit us at [digitaluk.co.uk](http://digitaluk.co.uk)  
Call us on **0845 6 50 50 50\***

\* Calls charged at BT rate of 3p pr minute daytime and 1p per minute evenings and weekends. Rates may vary for calls from non-BT lines.





**Remote control setup codes**  
**Codeeinstellung in die Fernbedienung**  
**Codes de la télécommande**  
**Instelcodes voor de afstandsbediening**

**Codici per il telecomando**  
**Códigos de acceso para el mando a distancia**  
**Códigos de introdução no telecomando**  
**Πίνακες κωδικών καταχώρισης τηλεχειριστηρίου**

**DVD**

DVD player  
 DVD recorder  
 DVD-R HDD  
 Blu-ray Disc

**STB**

Digital receiver  
 - DVB-T  
 Satellite receiver  
 - DVB-S  
 Cable receiver  
 - DVB-C

**HTS**

Home Theatre Systems  
 Amplifier

**DVD Codes**

**PHILIPS 0000, 0001, 0002, 0003, 0013, 0021, 0030, 0049, 0100, 0105, 0107, 0111, 0123, 0127, 0131, 0135, 0145, 0150, 0153, 0154, 0155, 0156, 0161, 0163, 0164, 0177, 0193, 0197, 0204, 0221, 0225, 0226, 0231, 0232, 0233, 0258, 0260, 0271, 0273, 0275, 0288, 0289, 0295, 0301, 0310, 0311, 0312, 0318, 0320, 0325, 0333, 0341, 0342, 0343, 0354, 0355**

Aiwa 0028, 0109, 0140, 0171, 0303

Aika 0020

Akura 0066

Alba 0004, 0118, 0119, 0129, 0195, 0256

Apex 0040

Bang & Olufsen 0071

Best Buy 0062

Bosston 0056

Brandt 0049, 0115, 0132, 0191

Brittannia 0053

Bush 0004, 0032, 0050, 0052, 0060, 0064, 0119, 0120, 0134, 0141, 0147, 0183, 0185, 0189, 0256

Cambridge Audio 0055, 0070

CAT 0057, 0058

Celestial 0068

Centrex 0144

Centrum 0058

CGV 0055

Cinevision 0063

Classic 0034

Clatronic 0060

Conia 0050

Crypto 0065

C-Tech 0126

CyberHome 0108, 0124, 0137

Daewoo 0007, 0008, 0009, 0125, 0139, 0261, 0286

Dalton 0069

Dansai 0054, 0188

Daytek 0110, 0121

DEC 0060

Denon 0015, 0039, 0166, 0173, 0184

Denver 0032, 0060, 0066, 0118, 0172, 0308

Denzel 0051

Desay 0059

Diamond 0055, 0126

Digitor 0067

DK Digital 0134, 0292

Dmtech 0005

Dual 0051

DVX 0126

Easy Home 0062

Eclipse 0055

Elta 0015, 0033, 0136

Eltax 0290

Emerson 0026

Enzer 0051

Finlux 0055

Fisher 0029

Gericom 0144

Global Solutions 0126

Global sphere 0126

Go Video 0018

Goldstar 0114

Goodmans 0004, 0060, 0064, 0119, 0144, 0147, 0169, 0179, 0187, 0236, 0256

Graetz 0051

Grundig 0021, 0031, 0139, 0144, 0148

H&B 0060, 0061

Haaz 0055, 0126

Harman/Kardon 0045

HiMAX0062

Hitachi 0018, 0037, 0051, 0062, 0196, 0209, 0284, 0302, 0317, 0330

Humax 0157

Innovation 0022, 0023, 0024, 0037

Jeutech 0056

JVC 0012, 0049, 0106, 0117, 0133, 0214, 0215, 0216, 0217, 0237, 0238, 0239, 0240, 0276, 0277, 0278, 0279, 0293, 0329, 0335

Kenwood 0015, 0043, 0138, 0181, 0186, 0300

Kingavon 0060

Kiss 0051, 0061

Koda 0060

KXD 0062

Lawson 0126

Lecson 0054

Lenco 0060

LG 0026, 0114, 0160, 0213, 0304, 0324, 0338, 0352, 0359

Life 0022, 0023, 0024

Lifetec 0022, 0023, 0024, 0037

Limit 0126

Loewe 0021, 0146, 0174

LogicLab 0126

Luxor 0144

Magnavox 0049, 0060, 0100

Magnum 0024, 0037

Marantz 0030, 0164, 0175, 0176

Matsui 0132, 0194

MBO 0046

Mediencom 0053

Medion 0006, 0022, 0023, 0024, 0037, 0064

Metz 0055

MiCO 0055

Micromaxx 0022, 0023, 0024, 0037

Micromedia 0049

Micromega 0105, 0271

Microstar 0022, 0023, 0024, 0037

Mirror 0064

Mitsubishi 0017, 0101

Mizuda 0060, 0062

Monyka0051

Mustek 0034, 0256, 0296

Mx Onda 0055

NAD 0044  
 Naiko 0144  
 Nakamichi 0048  
 Neufunk 0051  
 NU-TEC 0050  
 Omni 0053  
 Onkyo 0025, 0049, 0100, 0182  
 Optim 0054  
 Optimus 0019, 0103  
 Orava 0060  
 Orion 0185  
 Oritron 0024  
 P&B 0060  
 Pacific 0126  
 Palsonic 0052  
 Panasonic 0015, 0165, 0184, 0198, 0199,  
 0200, 0243, 0244, 0245, 0246, 0247,  
 0248, 0249, 0250, 0251, 0252,  
 0253, 0254, 0266, 0267, 0274,  
 0291, 0294, 0313, 0314, 0315,  
 0319, 0336, 0347, 0348, 0349,  
 0356, 0358  
 Philips Magnavox 0013  
 Pioneer 0019, 0103, 0112, 0113, 0116, 0128,  
 0149, 0159, 0180, 0201, 0202,  
 0203, 0206, 0207, 0208, 0242,  
 0255, 0263, 0305, 0321, 0326,  
 0327, 0328, 0337, 0344, 0345,  
 0346, 0353, 0357  
 Proline 0144, 0194  
 Provision 0060  
 Raite 0051  
 RCA 0035  
 REC 0052, 0053  
 RedStar 0066  
 Reoc 0126  
 Revoy 0061  
 Roadstar 0004, 0052, 0060  
 Rowa 0050, 0144  
 Rowsonic 0058  
 Saba 0115, 0132  
 Sabaki 0126  
 Sampo 0036  
 Samsung 0018, 0196, 0205, 0210, 0227,  
 0241, 0259, 0270, 0272, 0283,  
 0287, 0299, 0322, 0339, 0340  
 Sansui 0055, 0126  
 Sanyo 0257, 0262, 0285, 0298  
 ScanMagic 0256  
 Schneider 0004, 0005, 0006, 0024  
 Scott 0069, 0118  
 SEG 0004, 0042, 0051, 0126, 0152  
 Sharp 0022, 0044, 0130, 0151, 0268, 0280,  
 0350  
 Sherwood 0041

Shinco 0035  
 Sigmatek 0062  
 Silva 0066  
 Singer 0055, 0126  
 Skymaster 0033, 0034, 0126  
 Skyworth 0066  
 SM Electronic 0126  
 Sony 0014, 0104, 0109, 0122, 0171, 0178,  
 0192, 0222, 0223, 0224, 0228,  
 0229, 0230, 0282, 0297, 0306,  
 0309, 0316, 0323, 0351  
 Soundmaster 0126  
 Soundmax 0126  
 Standard 0126  
 Star Cluster 0126  
 Starmedia 0060  
 Supervison 0126  
 Synn 0126  
 Tatung 0125  
 TCM 0022, 0023, 0024, 0037, 0072, 0073,  
 0074, 0075, 0076, 0077, 0078,  
 0079, 0080, 0081, 0082, 0083,  
 0084, 0085, 0086, 0087, 0088,  
 0089, 0090, 0091, 0092, 0134,  
 0210, 0269, 0272  
 Teac 0019, 0050, 0126, 0168  
 Tec 0066  
 Technics 0170, 0184  
 Telefunken 0058  
 Tevion 0022, 0023, 0024, 0037, 0069, 0126  
 Thomson 0010, 0011, 0093, 0094, 0095,  
 0096, 0097, 0098, 0099, 0102,  
 0115, 0162, 0167, 0191, 0331, 0332  
 Tokai 0051, 0066  
 Toshiba 0013, 0049, 0100, 0142, 0161, 0190,  
 0211, 0212, 0218, 0218, 0220,  
 0234, 0235, 0264, 0265, 0281  
 TruVision 0062  
 Vtrek 0065  
 Wharfedale 0027, 0055, 0126  
 Wintel 0056  
 Xbox 0102, 0115  
 Xenon 0334  
 Xlogic 0126  
 XMS 0052  
 Yakumo 0144  
 Yamada 0144  
 Yamaha 0015, 0038, 0131, 0143, 0158, 0184,  
 0271, 0307

## STB Codes

**PHILIPS 0000, 0001, 0003, 0020, 0043,**  
**0066, 0068, 0069, 0073, 0085,**  
**0087, 0095, 0097, 0098, 0105,**  
**0109, 0113, 0114, 0117, 0122,**  
**0124, 0174, 0176, 0184, 0187,**  
**0206, 0207, 0208, 0211, 0213,**  
**0281, 0282, 0285, 0297, 0298,**  
**0301, 0304, 0325, 0331, 0358,**  
**0360, 0361, 0386, 0387, 0393,**  
**0395, 0412, 0421, 0429, 0434**  
 ABC 0432  
 AB Sat 0100, 0122, 0123, 0132  
 AGS 0122  
 Akai 0043, 0105  
 Alba 0002, 0003, 0004, 0005, 0031, 0045,  
 0087, 0107, 0123, 0209, 0270  
 Alcatel 0430, 0431  
 Aldes 0004, 0005, 0006, 0072, 0107  
 Allsat 0007, 0025, 0042, 0061, 0068, 0105  
 Allsonic 0005, 0010, 0072, 0108, 0115  
 Alltech 0089, 0123  
 Alpha 0105  
 Altai 0078  
 Amitronica 0123  
 Ampere 0008, 0078, 0222  
 Amstrad 0044, 0071, 0078, 0090, 0092, 0096,  
 0101, 0106, 0123, 0127, 0128,  
 0155, 0222, 0225, 0274, 0275,  
 0278, 0317, 0388, 0405,  
 Amstrad 0435  
 Anglo 0123  
 Ankaro 0005, 0010, 0069, 0072, 0108, 0115,  
 0123  
 Anttron 0002, 0005, 0068, 0087  
 Apollo 0002  
 Arcon 0008, 0009, 0026, 0094, 0222, 0280,  
 0405  
 Armstrong 0105, 0225  
 ASA 0079  
 Asat 0043, 0105  
 ASLF 0123  
 AST 0014, 0074  
 Astacom 0095, 0122  
 Aston 0053, 0271  
 Astra 0012, 0013, 0037, 0064, 0076, 0082,  
 0119, 0123, 0225  
 Astro 0005, 0006, 0010, 0017, 0066, 0087,  
 0108, 0113, 0114, 0115, 0116,  
 0119, 0283, 0392  
 AudioTon 0005, 0025, 0087  
 Aurora 0126  
 Austar 0126, 0157  
 Avalon 0078

Axiel 0122  
 Axis 0010, 0013, 0021, 0077, 0082, 0108,  
 0115, 0405  
 Barcom0009  
 Best 0009, 0010, 0108, 0115  
 Blaupunkt 0017, 0066, 0113  
 Blue Sky 0123, 0128  
 Boca 0037, 0059, 0085, 0091, 0123, 0222,  
 0225, 0237, 0242, 0251  
 Boston 0122, 0222  
 Brain Wave 0019, 0075, 0094  
 Brandt 0049, 0334, 0335, 0336  
 Broadcast 0018, 0076  
 Broco 0082, 0123  
 BSKyB 0101, 0155, 0183, 0216  
 BT 0122  
 BT Satellite 0049, 0095, 0277  
 Bubu Sat 0123  
 Bush 0003, 0007, 0020, 0031, 0045, 0061,  
 0068, 0107, 0200, 0207  
 BVV 0094  
 Cabletime 0406, 0407, 0408, 0424, 0426,  
 0428  
 Cambridge 0091, 0116  
 Canal Satellite 0073, 0109, 0114  
 Canal+ 0047, 0115  
 Channel Master 0004, 0107  
 Chaparral 0040  
 Cherokee 0122, 0132  
 Chess 0052, 0112, 0118, 0123, 0322  
 CityCom 0003, 0022, 0098, 0110, 0119,  
 0124, 0157  
 Clatronic 0019, 0075  
 Clemens Kamphus 0033  
 Clyde Cablevison 0409  
 CNT 0006  
 Colombia 0222  
 Columbia 0222  
 Columbus 0028  
 Comag 0222  
 Comcrypt 0433  
 Commander 0069  
 Commlink0005, 0072  
 Comtec 0021, 0072, 0077  
 Condor 0010, 0108, 0115, 0119  
 Connexions 0016, 0078, 0108, 0115, 0284  
 Conrad0084, 0085, 0108, 0110, 0115, 0116,  
 0119, 0222  
 Conrad Electronics 0119, 0123  
 Contec 0021, 0022, 0077, 0085  
 Cosat 0025  
 Crown 0225  
 Cryptovision 0410  
 Cybermax 0057  
 Daeryung 0016

Daewoo 0123, 0188  
 Dansat 0007, 0061, 0068  
 D-Box 0103  
 DDC 0004, 0107  
 Decca 0023  
 Delega 0004  
 Dew 0021, 0077  
 Diamond 0024  
 Digitality 0119  
 Digipro 0129  
 Discoverer 0112, 0118  
 Discovery 0122  
 Diseqc 0122  
 Diskxpress 0009, 0284  
 Distratel 0128  
 Distrisat 0105  
 Ditristrad 0025  
 DNR 0094  
 DNT 0016, 0043, 0078, 0105  
 Dong Woo 0036  
 Drake 0026, 0327  
 DStv 0126  
 Dune 0108, 0115  
 Dynasat 0121  
 Echostar 0016, 0052, 0078, 0102, 0109, 0123,  
 0132, 0279, 0286, 0287, 0288,  
 0294, 0342, 0343, 0344, 0345  
 Einhell 0002, 0005, 0071, 0072, 0116, 0123,  
 0222, 0225, 0275  
 Elap 0122, 0123  
 Elekta 0006  
 Elsat 0092, 0123  
 Elta 0002, 0010, 0025, 0043, 0105, 0108,  
 0115  
 Emanon 0002  
 Emme Esse 0010, 0020, 0033, 0102, 0108,  
 0115, 0121  
 Engel 0123  
 Ep Sat 0003  
 Eurieult 0111, 0127, 0128  
 Eurocrypt 0064  
 Eurodec 0055  
 Europa 0069, 0085, 0105, 0105, 0119  
 Europhon 0119, 0222  
 Eurosats 0225  
 Eurosky 0010, 0108, 0110, 0115, 0116,  
 0119, 0222, 0225  
 Eurostar 0104, 0110, 0119, 0121, 0124,  
 0225  
 Eutelsat 0123  
 Eutra 0089  
 Exator 0002, 0005, 0087  
 Fenner 0112, 0115, 0118, 0123  
 Ferguson 0003, 0007, 0020, 0055, 0061,  
 0068, 0182, 0289, 0290, 0291, 0391

Fidelity 0071, 0090, 0116, 0275, 0405  
 Finlandia 0003, 0064  
 Filmnet 0433  
 Filmnet Cablecrypt 0411, 0427  
 Filmnet Comcrypt 0411  
 Finlux 0003, 0030, 0064, 0080, 0084, 0292,  
 0363, 0413  
 Finnsat 0021, 0055  
 Flair Mate 0123  
 Foxtel 0126, 0131, 0157, 0435  
 Fracarro 0045, 0102  
 France Satellite/TV 0028  
 France Telecom 0429, 0434  
 Freebox 0210  
 Freecom 0002, 0032, 0113, 0116  
 Freesat 0089, 0127  
 FTE 0008, 0034, 0085, 0091, 0108, 0277  
 FTEmaximal 0115, 0123  
 Fuba 0002, 0009, 0010, 0012, 0016, 0017,  
 0028, 0030, 0043, 0064, 0078,  
 0108, 0110, 0113, 0115, 0323  
 Fugionkyo 0129  
 Galaxi 0009  
 Galaxis 0005, 0010, 0013, 0021, 0025, 0031,  
 0050, 0072, 0077, 0082, 0108,  
 0110, 0115, 0126, 0157, 0293,  
 0295, 0346  
 Galaxisat 0074  
 Gardiner 0124  
 GEC 0409  
 General Instrument 0425, 0432  
 GMI 0225  
 Goldbox 0073, 0109, 0114  
 Goldstar 0032  
 Gooding 0117, 0412  
 Goodmans 0003, 0031, 0186, 0195  
 Granada 0064  
 Grandin 0062, 0111  
 Grothusen 0002, 0032  
 Grundig 0003, 0005, 0017, 0020, 0044,  
 0054, 0065, 0066, 0097, 0101,  
 0106, 0113, 0116, 0117, 0126,  
 0128, 0155, 0166, 0167, 0169,  
 0175, 0282, 0298, 0325, 0388,  
 0393, 0405, 0412  
 G-Sat 0068  
 Hanseatic 0039, 0086, 0118  
 Haensel & Gretel 0119, 0222  
 Hantor 0002, 0019, 0036, 0075  
 Hanuri 0006  
 Hase & Igel 0094  
 Hauppage 0179, 0198  
 Heliocom 0008, 0119  
 Helium 0119  
 Hinari 0004, 0068, 0107

Hirschmann 0017, 0033, 0066, 0078, 0079,  
0081, 0084, 0113, 0115, 0116,  
0119, 0122, 0127, 0165, 0322,  
0323, 0328, 0389, 0413  
Hisawa 0019, 0075  
Hitachi 0003, 0020, 0212, 0313  
HNE 0222  
Houston 0025, 0069  
Humax 0157, 0161, 0163, 0190, 0215,  
0217, 0296, 0346  
Huth 0005, 0018, 0019, 0021, 0025, 0033,  
0069, 0072, 0075, 0076, 0077,  
0085, 0119, 0130, 0222, 0225, 0272  
Hypson0111  
ID Digital 0157  
Imex 0111  
Imperial 0031, 0045  
Ingelen 0127  
Innovation 0010, 0039, 0050, 0052, 0057,  
0297, 0303, 0347, 0372  
Inernational 0222  
Interstar 0129  
Intertronic 225  
Intervision 0025, 0088, 0119  
ITT/Nokia0003, 0020, 0064, 0079, 0084,  
0103, 0284, 0313, 0323, 0413  
Jerrold 0414, 0420, 0422, 0425, 0432  
Johansson 0019, 0075  
JOK 0093, 0095, 0122  
JSR 0025  
JVC 0117, 0186, 0412  
Kamm 0123  
Kathrein 0017, 0022, 0034, 0040, 0043, 0066,  
0081, 0087, 0098, 0105, 0110,  
0113, 0122, 0123, 0124, 0132,  
0152, 0157, 0159, 0160, 0189,  
0218, 0283, 0299, 0300, 0324,  
0362, 0371, 0381, 0392, 0395  
Kathrein Eurostar 0110  
Key West 0222  
Klap 0122  
Konig 0119  
Kosmos 0032, 0033, 0034, 0081  
KR 0005, 0087, 0089  
Kreiselmeier 0017, 0066, 0113  
K-SAT 0123  
Kyostar 0002, 0087, 0222  
L&S Electronic 0115, 0222  
Lasat 0006, 0010, 0035, 0036, 0037, 0077,  
0091, 0108, 0110, 0112, 0115,  
0119, 0222, 0334, 0335, 0336  
Lemon 0094  
Lenco 0002, 0032, 0038, 0069, 0082, 0094,  
0108, 0110, 0115, 0119, 0123, 0277  
Leng 0019  
Lennox 0025  
Lenson 0029, 0116  
Lexus 0105  
LG 0032  
Life 0050  
Lifesat 0010, 0039, 0050, 0052, 0057, 0086,  
0108, 0112, 0115, 0118, 0123,  
0222, 0297, 0303, 0347, 0372  
Lifetec 0010, 0039, 0050, 0052, 0057, 0297,  
0303, 0347, 0372  
Lorenzen 0069, 0094, 0096, 0119, 0222  
Lorraine 0032  
Lupus 0010, 0108, 0115  
Luxor 0064, 0084, 0103, 0106, 0116, 0275,  
0313, 0323, 0388  
Lyonnaise 0055  
M & B 0086, 0118  
Macab 0055, 0434  
Manata 0095, 0111, 0122, 0123, 0222  
Manhattan 0003, 0006, 0020, 0025, 0095,  
0122, 0269, 0383  
Marantz 0043  
Mascom 0006, 0081  
Maspro 0003, 0020, 0040, 0063, 0066, 0089,  
0094, 0113, 0117, 0123, 0289,  
0328, 0393, 0412  
Matsui 0049, 0066, 0095, 0107, 0113, 0117,  
0122, 0412  
Max 0119  
MB 0039, 0086, 0118  
Mediabox 0073, 0109, 0114  
Mediamarkt 0225  
Mediasat 0013, 0073, 0082, 0109, 0114,  
0116  
Medion 0010, 0039, 0050, 0052, 0057, 0108,  
0115, 0123, 0222, 0297, 0303,  
0335, 0347, 0372  
Medison 0123  
Mega 0043, 0105  
Melectronic 0124  
Metronic 0002, 0005, 0006, 0009, 0062,  
0072, 0087, 0098, 0111, 0123,  
0124, 0128, 0359, 0366, 0367,  
0368, 0369, 0382  
Metz 0017, 0066, 0113  
Micro Electronic 0116, 0119, 0123  
Micro Technology 0082, 0123  
Micromaxx 0010, 0039, 0050, 0052, 0057,  
0115, 0297, 0303, 0347, 0372  
Microstar 0010, 0039, 0050, 0052, 0057,  
0297, 0303, 0347, 0372  
Microtec 0123  
Minerva 0017, 0117, 0412  
Mitsubishi 0003, 0017, 0049  
Mitsumi 0037  
Mnet 0427, 0433  
Morgan Sydney 0056  
Morgan's 0037, 0043, 0085, 0091, 0105,  
0123, 0222, 0225  
Motorola 0125  
Movie Time 0419  
Mr Zapp 0434  
Multichoice 0054, 0126, 0433  
Multistar 0034, 0036  
Multitec 0052, 0112, 0347  
Muratto 0015, 0032, 0074  
Mysat 0123  
Navex 0019, 0075  
NEC 0041, 0067, 0302  
Network 0068  
Neuhaus 0013, 0025, 0029, 0069, 0082,  
0085, 0094, 0116, 0119, 0123  
Neusat 0094, 0123  
NextWave 0051, 0130, 0273  
Nikko 0123, 0225  
Nokia 0003, 0020, 0064, 0079, 0084, 0103,  
0114, 0156, 0170, 0196, 0221,  
0233, 0235, 0241, 0253, 0254,  
0257, 0262, 0263, 0264, 0265,  
0284, 0310, 0311, 0320, 0323,  
0332, 0333, 0396, 0400, 0413  
Nomex0058  
Nordmende 0002, 0003, 0004, 0006, 0055,  
0075, 0107, 0290, 0324, 0391  
Noos 0434  
Nova 0126  
Novis 0019, 0075  
Oceanic 0024  
Octagon 0002, 0005, 0021, 0077, 0087  
Okano 0033, 0034, 0225  
Ondigital 0070, 0386, 0387  
Optex 0022, 0025  
Optus 0114, 0126, 0130  
Orbit 0014  
Orbitech 0002, 0083, 0085, 0112, 0114,  
0116, 0390  
Osat 0005, 0106, 0388  
Otto Versand 0017  
Pace 0003, 0007, 0017, 0020, 0031, 0044,  
0061, 0068, 0070, 0101, 0122,  
0132, 0155, 0183, 0199, 0201,  
0202, 0203, 0205, 0289, 0301,  
0307, 0329, 0394  
Pacific 0024  
Packsat 0122  
Palcom 0004, 0012, 0028, 0029, 0107  
Palladium 0116, 0117, 0225, 0412  
Palsat 0112, 0116  
Paltec 0012  
Panasat 0120, 0126



Panasonic 0003, 0020, 0044, 0101, 0155, 0192, 0318	Sat Team 0123	Start Trak 0002
Panda 0003, 0007, 0061, 0064, 0113, 0119	Satcom 0018, 0039, 0076, 0086, 0118, 0119, 0306	Strong 0002, 0005, 0010, 0032, 0045, 0108, 0114, 0115, 0126, 0129, 0231, 0232, 0234, 0238, 0243, 0245, 0253, 0266, 0284
Patriot 0122, 0222	Satec 0020, 0068, 0123	STVO 0111
Phoenix 0021, 0031, 0068, 0077	Satelco 0108, 0115	Sumida 0225
Phonotrend 0003, 0005, 0025, 0033, 0072, 0346	Satford 0018, 0076	Sunny Sound 0108, 0115
Pioneer 0109, 0114, 0197, 0373, 0405, 0415, 0416	Satline 0088	Sunsat 0082, 0123
Polsat 0055	Satmaster 0018, 0076	Sunstar 0037, 0108, 0115, 0222, 0225, 0307
Polytron 0022	SatPartner 0002, 0005, 0006, 0019, 0032, 0033, 0075	Super Sat 0121
Predki 0019, 0075	Satplus 0112	Supermax 0130
Preisner 0078, 0085, 0091, 0222	Schacke 0087	Systec 0222
Premiere 0025, 0047, 0073, 0109, 0114, 0157, 0253, 0254, 0266	Schneider 0010, 0050, 0052, 0057, 0097, 0112, 0122, 0285, 0303, 0347, 0385	Tandberg 0055
Priesner 0225	Schwaiger 0022, 0024, 0039, 0051, 0068, 0085, 0086, 0112, 0118, 0119, 0128, 0222, 0272, 0299, 0305, 0335, 0337, 0339, 0340, 0341, 0346, 0347, 0357, 0370, 0383, 0385	Tandy 0005
Profile 0038, 0122	Scientific Atlanta 0417, 0418	Tantec 0003, 0020, 0028, 0029, 0289
Promax0003	SCS 0110	Tatung 0023
Prosat 0004, 0005, 0031, 0045, 0072, 0088, 0107, 0270	Sede Electronique 0129, 0222	TCM 0010, 0039, 0050, 0052, 0057, 0133, 0134, 0135, 0136, 0137, 0138, 0139, 0140, 0141, 0142, 0143, 0144, 0145, 0146, 0147, 0148, 0297, 0303, 0347, 0372
Prosonic 0096	Seemann 0013, 0016, 0082, 0108, 0225	Techniland 0018, 0076
Protek 0024	SEG 0002, 0010, 0019, 0039, 0075, 0086, 0096, 0108, 0115, 0118, 0139, 0229, 0231, 0234, 0250, 0258, 0317, 0384	TechniSat 0016, 0029, 0060, 0083, 0105, 0112, 0114, 0116, 0150, 0151, 0164, 0185, 0194, 0213, 0214, 0220, 0224, 0226, 0236, 0239, 0240, 0260, 0267, 0308, 0309, 0390, 0398
Provision 0006	Seleco 0025, 0102	Technology 0126
PVP Stereo Visual Matrix 0422	Septimo 0128	Technosat 0130
Pye 0117	Servi Sat 0111, 0123	Technowelt 0119, 0128, 0222
Quadral 0004, 0005, 0010, 0072, 0085, 0088, 0095, 0107, 0108, 0115, 0122, 0132	Siemens 0017, 0066, 0091, 0113	Teco 0037, 0225
Quelle 0017, 0071, 0110, 0119, 0275	Silva 0032	Tele+1 0411, 0427, 0433
Quiero 0055	Skantin 0123	Telanor 0004
Radiola 0043, 0105	Skardin 0013, 0082	Telesat 0039, 0086, 0110, 0118, 0119
Radix 0016, 0078, 0089, 0127, 0191, 0247, 0256, 0380, 0397, 0399	Skinsat 0116	Teleciel 0087
Rainbow 0005, 0087, 0089	SKR 0123	Telecom 0123
Rediffusion 0041	SKY 0125	Teledirekt 0068
Redpoint 0013, 0082	Sky Digital 0044	Telefunken 0002, 0020, 0049, 0095, 0122, 0330, 0334, 0335, 0336
RedStar 0010, 0108, 0115	Skymaster 0005, 0039, 0052, 0072, 0086, 0088, 0104, 0112, 0118, 0123, 0139, 0149, 0158, 0219, 0227, 0246, 0249, 0255, 0268, 0321, 0322, 0347, 0348, 0349, 0350, 0351, 0352, 0374	Teleka 0005, 0016, 0078, 0081, 0087, 0094, 0116, 0119, 0225, 0280, 0393
RFT 0005, 0043, 0069, 0072, 0083, 0105	Skymax 0043, 0105	Telemaster 0006
Roadstar 0123	SkySat 0112, 0116, 0118, 0119, 0123	Telemax 0035
Roch 0111	Skyvision 0025	Telepiu 0427, 0433
Rover 0088, 0115, 0123	SL 0094, 0222	Telesat 0039, 0086, 0118, 0119
Ruefach 0038	SM Electronic 0112, 0123	Telestar 0029, 0112, 0114, 0116
Saba 0006, 0020, 0045, 0068, 0093, 0094, 0095, 0110, 0119, 0122, 0128, 0270, 0289, 0290, 0319, 0326, 0334, 0337, 0338, 0339, 0340, 0391	Smart 0110, 0123, 0127, 0222	Teletech 0104
Sabre 0003	Sony 0044, 0114, 0276	Televos 0003, 0056, 0222, 0365
Sagem 0055, 0099, 0434	SR 0037, 0222, 0225, 0290	Telewire 0025
Sakura 0021, 0031, 0077	Starcom 0432	Tempo 0130
Salora 0041, 0064, 0302, 0307	Starland 0052, 0123	Tevion 0010, 0039, 0050, 0052, 0057, 0123, 0297, 0303, 0347, 0372
Samsung 0002, 0153, 0154, 0162, 0193, 0204, 0280	Starring 0019, 0075	
SAT 0004, 0014, 0015, 0074, 0090, 0116, 0405		
Sat Cruiser 0130		
Sat Partner 0116		





---

## Contact information

---

Type no. \_\_\_\_\_

Product no. \_\_\_\_\_



België / Belgique 078 250 145	€0.06/min	Italia 8403 20086	€0.08/min	Svenska 08 5792 9100	Local
Danmark 3525 8759	Local	Luxembourg 40 6661 5644	Locale	Suomi 09 2311 3415	Local
Deutschland 01803 386 852	€0.09/min	Nederland 0900 8407	€0.10/min	United Kingdom 0870 900 9070	Local
France 0821 611 655	€0.09/min	Norge 2270 8111	Local		
ΕΛΛΑΣ 0 0800 3122 1280	Δωρεάν	Österreich 0810 000205	€0.07/min		
España 902 888 784	€0.10/min	Portugal 2 1359 1442	Local		
Ireland 01 601 1777	Local	Schweiz / Suisse / Svizzera 0844 800 544	Local		



Specifications are subject to change without notice  
Trademarks are the property of Koninklijke Philips Electronics N.V.  
or their respective owners  
2008 © Koninklijke Philips Electronics N.V. All rights reserved

[www.philips.com](http://www.philips.com)



Printed in Belgium